

Impaq Glass Break

Acoustic Glass Break Detector

INSTALLATION INSTRUCTIONS



THANK YOU FOR VOTING TEXECOM

Ask your distributor today for the full colour Product Guide.

Texecom
www.texe.com

INS 229-2

QUALITY ASSURANCE



Certificate Number: FM 35285



Impaq Glass Break is a trademark of Texecom Ltd.

Registered Design Number: 2105723

Document Ref: ImpGB/EU/1.0

© 2002 - 2003 Texecom Ltd

7 POSITIONING THE DETECTOR

- Mount the detector in the same room as the window to be detected.
- Avoid installing in rooms smaller than 3 x 3m or larger than 15 x 15m, or where the ceiling is higher than 5m.
- Avoid mounting the detector on the same wall as the window to be protected.
- The detector can be installed in the corners of rooms, but this reduces detector efficiency.
- Mount the detector at least 1m away from the protected glass.
- Avoid installation in a noisy environment. If you can't hear the window smash, neither can the detector.
- Only install the detector on a sturdy vibration free surface. Brick or concrete walls are suitable.
- Direct line sight is preferred for better detection. Obstacles, like blinds or curtains, obstruct the sound and may reduce the detector's ability to operate successfully.
- Keep this detector away from excessive humidity or damp as it is not a sealed unit and may suffer damage.

1 PHYSICAL

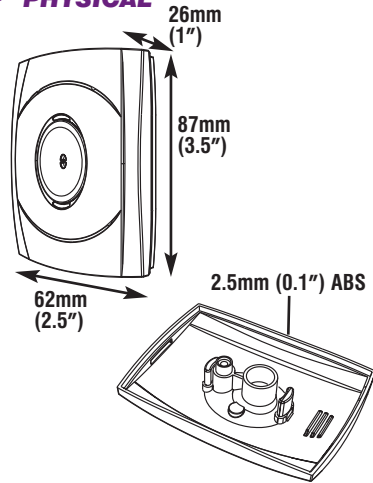

2 ENVIRONMENTAL

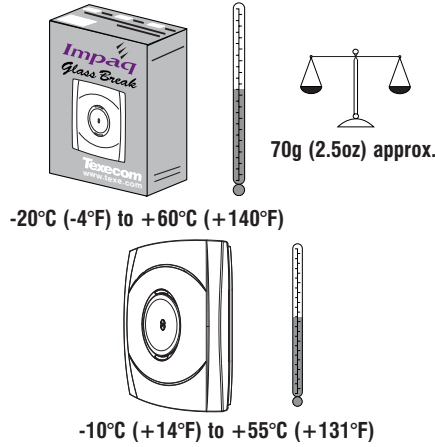

3 FALSE ALARM PROTECTION

- Design:** Noise reduction circuits with maximum ground plane.
- RF Immunity:** No false alarm from 80MHz to 1GHz at 10V/m. Complies with BS EN 61000-4-3 : 1997.
- Electrostatic Discharge:** No false alarm up to 8kV. Complies with BS EN 61000-4-2 : 1995.
- Fast Transient Immunity:** No false alarm up to ±1kV. Complies with BS EN 61000-4-4 : 1995.
- High Energy Transient Immunity:** No false alarm up to ±1kV. Complies with BS EN 61000-4-5 : 1995.
- Conducted RF Susceptibility:** No false alarm at 10Vrms. Complies with BS EN 61000-4-6 : 1996.
- Conducted Emissions:** Complies with EN 55022 Class B.
- Radiated Emissions:** Complies with EN 55022 Class B.
- EMC:** Independently certified to EN 50130-4 : 1996. Multi-frequency analogue and digital filters screen out potential false alarms.

4 SPECIFICATIONS

- Supply Voltage:** 9 - 16Vdc
- Current Consumption (standby):** 11mA
- Current Consumption (alarm):** 10mA
- Weight (detector):** 60g (2.1oz)
- Weight (detector & packaging):** 74g (2.6oz)
- Sensor Type:** Extended Response Electret Microphone
- Minimum Window Size, all types:** 300mm x 300mm
- Glass Type Detection:** Plate Tempered Laminated Wired
- Glass Thickness, all types depending on room acoustics:** 2.4 - 6.4mm
- Maximum Range:** 9m, 170°
- Alarm Relay Output:** Normally Closed
- Contacts Rating:** <24Vdc, 50mA, (185)

5

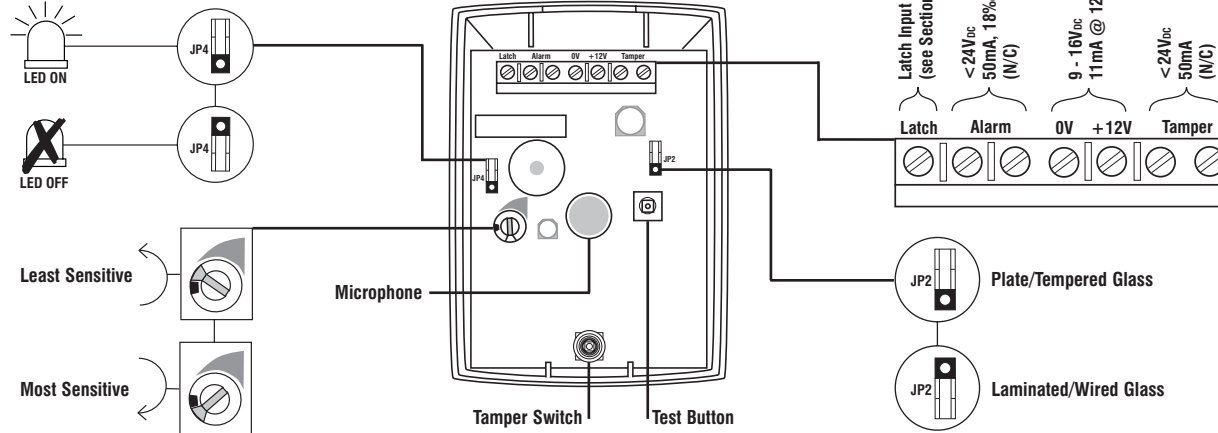

6 DETECTOR KNOCKOUTS

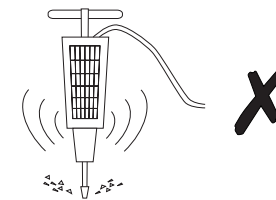
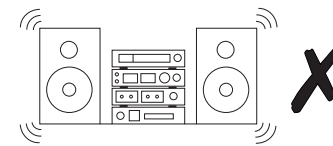
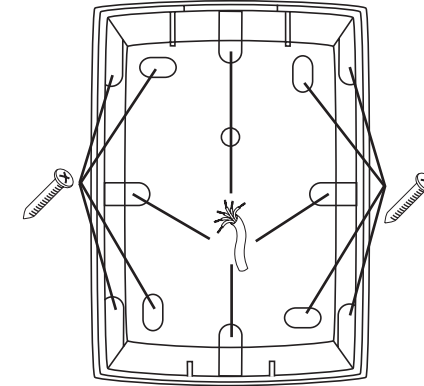

Do not install detector in noisy environments

Please Note

- This detector is not designed to respond to breaking glass which is not in a sturdy frame, e.g. breaking bottles.

Glass Type Definitions

Plate: Primarily used for older windows or small single and double glazed units. Broken plate glass results in large sharp shards.

Tempered: This has been heat treated for additional strength (toughened glass). Upon breaking, it shatters into small cubes.

Laminated: Used in larger windows, patio doors, internal and external doors. Laminated glass does not shatter, as it has a plastic film within the glass pane.

Wired: This glass has a wire frame within it for added security and strength.

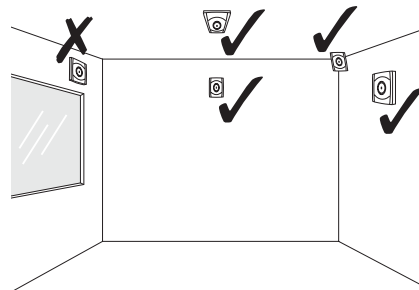

WARRANTY

12 month replacement warranty.

The Impaq Glass Break is designed to detect the sound of breaking glass and activate an alarm control panel. As the Impaq Glass Break is not a complete alarm system, but only a part thereof, Texecom cannot accept responsibility or liability for any damages whatsoever based on a claim that the Impaq Glass Break failed to function correctly. Under very rare conditions, it may be possible for a combination of random sounds to trigger an alarm. This is unavoidable due to the complex nature of glass break waveforms. The detector is not guaranteed to respond if any type of plastic film has been adhered to the protected windows prior to smashing. Window cracking due to the application of slow pressure may not cause an alarm, as the detector is not designed for this. To ensure greater intruder detection, use this detector with other interior sensors since acoustic glass break detectors may not detect every glass break event. Due to our policy of continuous improvement Texecom reserves the right to change specification without prior notice.

8 DETECTOR COVERAGE

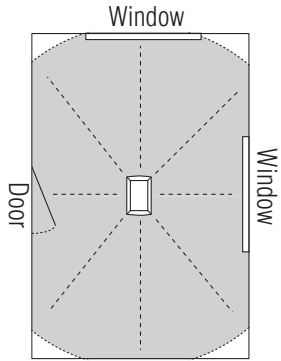

Ceiling Mounted

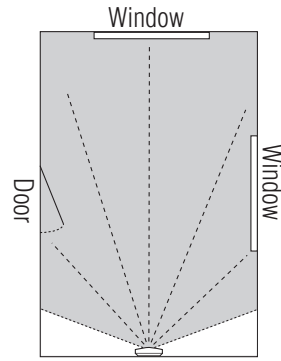

Wall Mounted

9 MOUNTING THE GLASS BREAK

For indoor use only

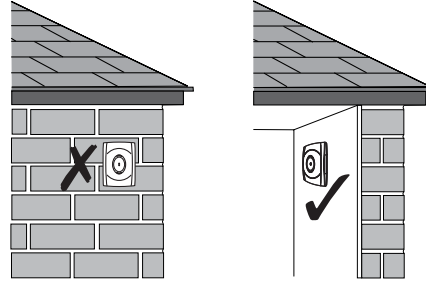

10 MOUNTING THE GLASS BREAK

Mount on a stable surface

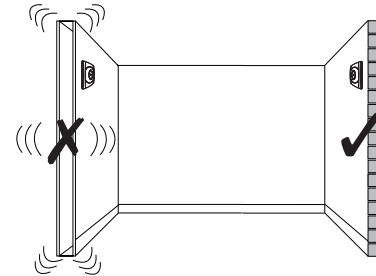

11 WIRING

Do not run cable parallel to mains wiring

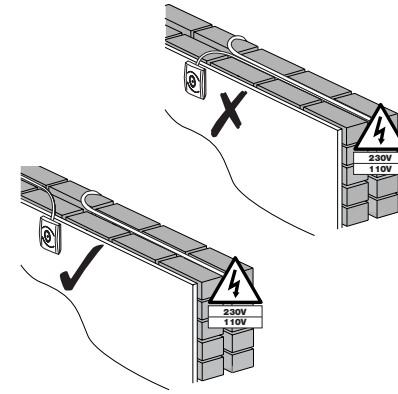

INS 229-2

12 WIRING

Refer to Figure 6 to select knockouts for chosen cable entry route. Connect wires to the terminal block in the following order (see Figure 5):

TERMINAL

LATCH Latch/First to Alarm input. Connect to 'Set Positive' or 'Alarm Positive' on alarm control panel.

ALARM Alarm relay contacts. Connect to a normally closed intruder zone on the alarm control panel.

Normally closed relay contacts protected by an 18Ω series resistor.

Open on glass break detection or power failure.

0V Connect to auxiliary 0Vdc on the alarm control panel.

12V Connect to auxiliary +12Vdc on the alarm control panel.

TAMPER Connect to a normally closed tamper zone on the alarm control panel.

Normally closed switch contacts open on removal of front cover.

Note

- Alarm cable should not be run alongside/parallel to mains wiring.
- To comply with EU Directives the *Impaq Glass Break* must be connected to a power supply source supplied from an isolating transformer.

13 DO'S AND DONT'S

- Test regularly to ensure continuous protection.
- It is not recommended to connect a detector to a 24 hour zone unless the room is unoccupied.
- Cracked glass should be replaced, since breaking an already cracked window may be harder to detect.
- Not suitable for stained or leaded glass.
- When testing the glass break detector, check the alarm panel responds as well as the red LED.
- Avoid placing large objects on the window sill, as these could disrupt the detectors line of sight, therefore reducing detection capability.

14 LATCH INPUT FUNCTIONS

The latch terminal (see Section 5) can perform several different functions depending on how it is connected:

Latch Connected to Set Positive (SW+, Set+): The LED's will be disabled while the system is set. Any detectors triggered while the system is set will indicate this by permanently lighting the red LED (upon unsetting the system). Detectors can be reset by taking the latch line high and then low again.

Latch Connected to Alarm Positive (AL+, A+ve): The first detector activated while the system is set will indicate this with a slowly flashing red LED (upon unsetting the system). Detectors which activated subsequently will indicate this by permanently lighting the red LED. Detectors can be reset by taking the latch line high and then low again.

15 TESTING

For control locations, refer to Section 5.

Temporarily mount the detector in a suitable position, and connect to a portable supply e.g. 12V battery.

Remove the cover, then ensure that the gain control is set fully anti-clockwise (minimum setting).

With the latch input disconnected, push and hold the test button for at least 1 second and the green LED will flash, indicating that the detector is now in test mode.

Replace the cover and the screw cap.

Proceed to the protected window and thump the centre of the glass carefully, allowing the glass to resonate.

To get the correct sensitivity remove the cover, gradually turn the gain control clockwise, replace the cover and when the window is thumped, the red and green LED's will light simultaneously for 2 seconds.

If the sensitivity is too low the green LED will light for 2 seconds.

Leaving Test Mode

The unit will reset to normal mode 5 minutes after the test mode was activated. Alternatively the test mode can be cancelled by pressing and holding the test button for at least 1 second.

When the device has left test mode, the green LED will stop flashing.

Note

If during operation, the green LED is lit frequently, the gain may need adjusting, to prevent false alarms. If this condition still persists, move the detector to a better location away from constant noise.

Re-Test

This glass break detector will not respond reliably to glass break simulators, due to the high selectivity of sounds required. To temporarily down-grade the signal processing capability of the detector remove the cover, push and hold the test button for at least 1 second, then replace the cover and the screw cap. The detector will remain in test mode for a further 5 minutes, or until cancelled by pressing and holding the test button for at least 1 second. Proceed to the protected window, and activate the glass break simulator from the centre of the glass aiming the sound towards the detector.

To get the correct sensitivity remove the cover, gradually turn the gain control clockwise, replace the cover and when the glass break simulator is activated the red and green LED's will light simultaneously for 2 seconds. If the sensitivity is too low the green LED will light for 2 seconds.

16 MOUNTING THE GLASS BREAK

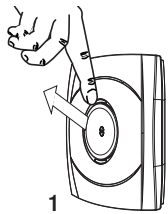

1

Turn screw anti-clockwise.
Note: Screw does not come out of lid.

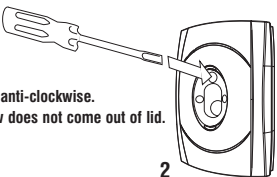

2

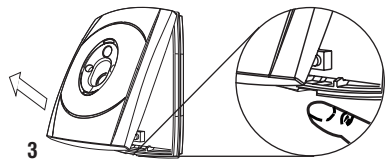

3

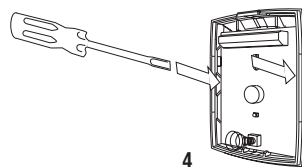

4

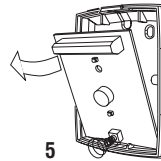

5

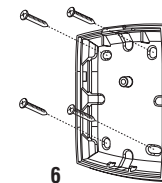

6

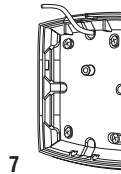

7



8

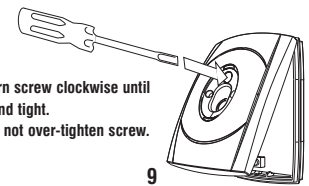

9

Turn screw clockwise until hand tight.
Do not over-tighten screw.

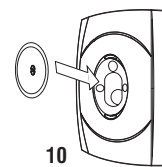

10