

F-COM

 EN 54-2
EN 54-4
EN 54-21
0051
0051-CPR-1754



F-COM

Telephone communicator

Installation and User manual

ELECTRONICS



INIM Electronics s.r.l. (Seller, Our, Us) warrants the original purchaser that this product shall be free from defects in materials and workmanship under normal use for a period of 24 months. As INIM Electronics s.r.l. does not install this product directly, and due to the possibility that it may be used with other equipment not approved by Us; INIM Electronics s.r.l. does not warrant against loss of quality, degradation of performance of this product or actual damage that results from the use of products, parts or other replaceable items (such as consumables) that are neither made nor recommended by INIM Electronics. Seller obligation and liability under this warranty is expressly limited to repairing or replacing, at Seller's option, any product not meeting the specifications. In no event shall INIM Electronics s.r.l. be liable to the purchaser or any other person for any loss or damage whether direct or indirect or consequential or incidental, including without limitation, any damages for lost profits, stolen goods, or claims by any other party caused by defective products or otherwise arising from the incorrect or otherwise improper installation or use of this product.

This warranty applies only to defects in parts and workmanship relating to normal use. It does not cover:

- damage arising from improper maintenance or negligence
- damage caused by fire, flood, wind or lightning
- vandalism
- fair wear and tear

INIM Electronics s.r.l. shall, at its option, repair or replace any defective products. Improper use, that is, use for purposes other than those mentioned in this manual will void the warranty. Contact Our authorized dealer, or visit our website for further information regarding this warranty.

INIM Electronics s.r.l. shall not be liable to the purchaser or any other person for damage arising from improper storage, handling or use of this product.

Installation of this Product must be carried out by qualified persons appointed by INIM Electronics. Installation of this Product must be carried out in accordance with Our instructions in the product manual.

The information contained in this document is the sole property of INIM Electronics s.r.l. No part may be copied without written authorization from INIM Electronics s.r.l.

All rights reserved.

Warranty

Limited warranty

Copyright

Table of contents

Warranty	2
Limited warranty	2
Copyright	2
Table of contents	3
Chapter 1 General information	5
1-1 Manufacturer's details	5
1-2 About this manual	5
1-3 Included documents	5
Chapter 2 Device description	6
2-1 Unpacking the box	6
2-2 Technical description	7
2-3 CE Mark	9
Chapter 3 Installation	10
3-1 Wall-mounting	10
3-2 Connecting the switching power supply	10
3-3 Mounting the Antenna	12
3-4 Telephone connections	12
3-5 Connecting to a PC	13
3-6 Connecting the terminals	13
Chapter 4 First startup	18
4-1 Guided programming (initial setup wizard)	18
Chapter 5 Using the communicator	20
5-1 Users	20
5-2 User interface	20
5-3 Language used by the user interface	22
5-4 Signals on the display	23
5-5 Main menu	24
Appendix A Events	25
Appendix B Simplified declaration of conformity	28
WEEE	31

GENERAL INFORMATION

Manufacturer's details 1-1

Manufacturer: INIM Electronics s.r.l.
Production plant: Centobuchi, via Dei Lavoratori 10
Comune: 63076, Monteprandone (AP), Italy
Tel.: +39 0735 705007
Fax: +39 0735 704912
e-mail: info@inim.biz
Web: www.inim.biz

The persons authorized by the manufacturer to repair or replace the parts of this system have authorization to work on INIM Electronics brand devices only.

About this manual 1-2

Manual code: DCMIINIEFCOM
Revision: 1.00

Included documents 1-3

- Installation and User manual (this manual)
- Programming manual

The manuals are supplied with the apparatus and can be downloaded from the "Download" section of the Website: www.inim.biz. The installation manual is included in the package. To order further copies contact the offices at INIM Electronics.

Chapter 2

DEVICE DESCRIPTION

The F-COM is a universal autonomous telephone communicator, certified in accordance with EN 54-21 and EN 54-4 standards. It is to be used with fire detection control panels manufactured both by Inim Electronics and other manufacturers.

It is capable of operating as:

- fire alarm transmission device (device E for EN 54-1)
- fault signal transmission device (device J for EN 54-1)

The communicator operates autonomously:

- It detects control panel alarm and fault events through input terminals, as well as its own internal events.
In *Appendix A* you can find the complete list of events generated.
- Activates programmable outputs.
- Makes voice calls over the PSTN line or GSM mobile network.
The default voice messages can be replaced by recorded custom messages.
- Sends digital messages using Contact ID protocol (over the PSTN line or GSM mobile network) and SIA-IP (over mobile data network).
- Sends SMS messages over GSM network.
The default messages can be replaced by custom text messages.
- Provides communication feedback through the ALARM ACK output terminal and LED signals.

INIM does not ensure full availability of all the GSM functions described in this manual for the various combinations of GSM service provider, SIM type and telephone set used.

ATTENTION!

Unpacking the box 2-1

The device is packed in a cardboard box which contains:

- The F-COM inside its metal enclosure
- A bag containing the installation kit comprising:
 - 3 x 3k9 Ohm 1/4W resistors
 - 5 x 100 Ohm 1/4W resistors
 - 1 x 1500 Ohm 1/4 W resistor
 - 1 jumper
 - battery connection wires
 - thermal probe
 - ring terminal for the connection to Ground
- Antenna
- Installation manual (this manual)

The installation kit does not include:

- 12V 1.3A/h batteries
- SIM Card

Be sure to have these items on hand before starting the installation procedure.

Note

Technical description 2-2

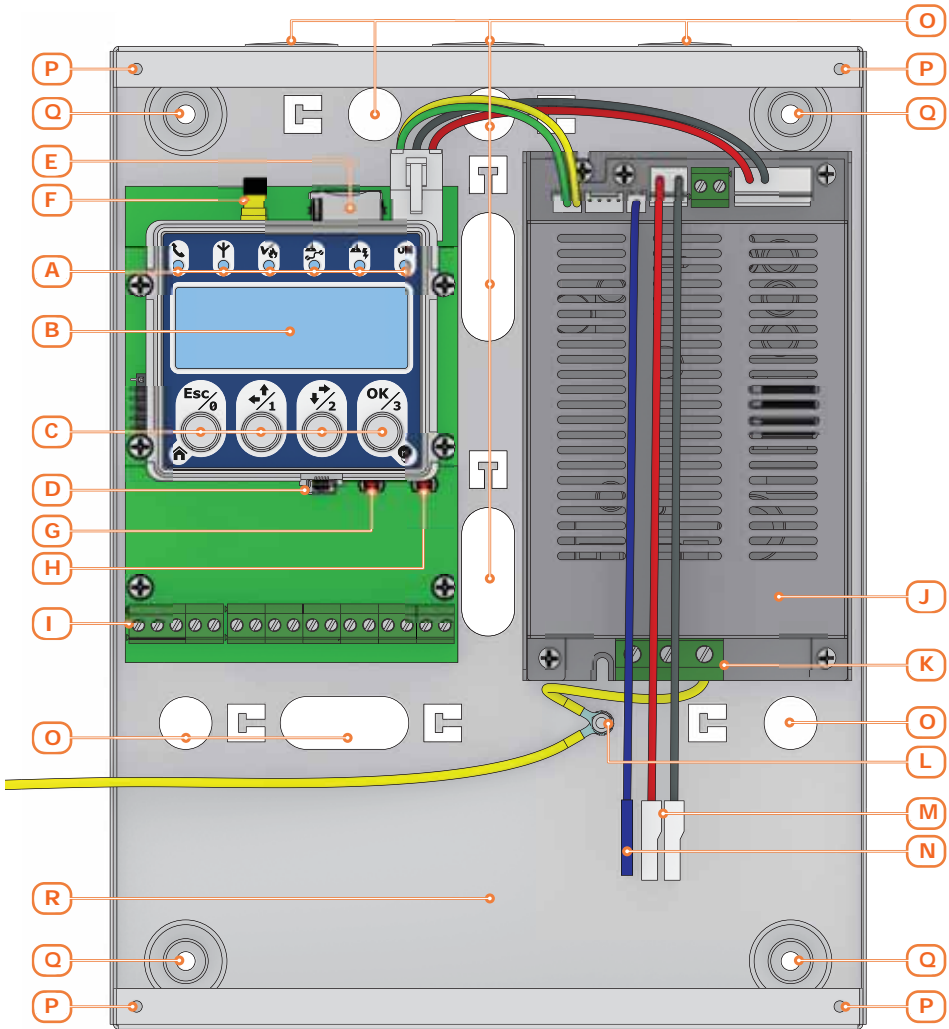

Table 1: Description of parts

A	Signalling LEDs
B	Display
C	Navigation buttons
D	USB Port
E	SIM card connector
F	Antenna connector
G	RESET button to restart the communicator
H	FACTORY button to restore factory settings
I	Terminal board

J	Power supply
K	Mains power terminals
L	Ground connection point
M	Battery terminals
N	Thermal probe
O	Cable entry hole
P	Frontplate anchor hole
Q	Backplate anchor hole
R	Battery housing

Table 2: Terminal board

n.	icon/identifier	function
1		Ground terminal
2, 3	L.E.	Telephone line connection terminals
4, 5	L.I.	Internal telephone line terminals
6	ALARM ACK	Output terminal for confirmation of receipt of an alarm communication
7	OUT1	Programmable output terminal (by default it activates in the event of a connection fault)
8	FAULT	Output terminal that activates in the presence of communicator faults
9, 13	-	Ground reference
10, 11, 12	IOx	Programmable input/output terminals
14, 15	ALARM CALL	Input terminal for the activation of alarm communications
16, 17	FAULT CALL	Input terminal for the activation of fault communications

Table 3: Technical specifications

Supply voltage		230V~ (-15% + +10%) 50/60Hz
Maximum absorption from the 230V line		0.5A
AC mains input terminals		
Nominal output voltage		27.6V
Maximum current supplied by the power-supply module	total	2.1A
	for battery charging	0.6A
	for external loads and main board	1.5A
Main board current absorption	during standby	50mA
	during alarm	150mA
Battery specifications		2 x 12V / 1.3Ah
Minimum flammability class of casing		UL94-V2
Maximum internal resistance of battery ($R_{i \max}$)		2.70hm
Output voltage		19 / 27.6V
Battery shutdown tension		19V
Internal fuse of power supply module		T 3.15A 250V
Maximum output current ripple		1%
Operating temperature		from -5°C to 40°C
Insulation class		I
Enclosure protection class (EN 60529)		IP30
Classification in accordance with EN 54-21		Type 2
Dimensions (H x W x D)		260 x 200 x 55mm
Weight (without batteries)		1500g



0051

INIM Electronics s.r.l.
Via Dei Lavoratori 10 - Fraz. Centobuchi
63076, Monteprandone (AP) - Italy

19

0051-CPR-1754

EN 54-4:1997 + A1:2002 + A2:2006
EN 54-21:2006

F-COM

Alarm transmission and fault warning routing equipment with embedded power supply equipment for use with fire detection and fire alarm systems installed in buildings

Essential features		Performance
Power supply performance		PASS
Transmission performance		PASS
Operating reliability		PASS
Durability of operating reliability:	Thermal resistance	PASS
	Vibration resistance	PASS
	Humidity resistance	PASS
	Electrical stability	PASS
Additional information according to EN 54-4		
For the information required by point 7.1, see data contained in this manual.		
Additional information according to EN 54-21		
For the information required by point 7.2.1, see data contained in this manual.		

Chapter 3

INSTALLATION

Wall-mounting 3-1

The installation must be carried out in full compliance with local fire regulations, with the laws and provisions in force, and in accordance with the relative instructions and guidelines.

The communicator should be located in a place that is:

- Dry
- Away from electromagnetic interference (electrical equipment, heating units, air-conditioning units, radio transmitters, etc.) and metal objects.

Check that the GSM network signal of the selected provider is adequate.

ATTENTION!

1. Remove the securing screws and frontplate (*table 1, P*).
2. Using the back of the enclosure (*table 1, Q*), mark the anchor screw locations on the wall. Be sure not to drill in the vicinity of electrical wiring or plumbing/gas pipes, etc.
3. Insert the screw anchors (recommended size 6mm).
4. Pull the connection wires through the wire entry (*table 1, O*).
5. Using the respective screws, attach the box to the wall.
6. Complete the connections with the terminals.
7. Replace the frontplate.

Connecting the switching power supply 3-2

The F-COM must be powered via the 230V~ mains power supply, with necessary use of the two backup batteries.

Mains power 230V~ 3-2-1

For the power supply from the network, it is necessary to provide a separate line deriving from the electrical distribution panel. The line must be protected by a safety-standards compliant circuit breaker (trip switch).

The Grounding system of the site must be made in accordance with the current regulations in force.

Use extreme caution when connecting to the primary power source. Danger of electric shock.

ATTENTION!

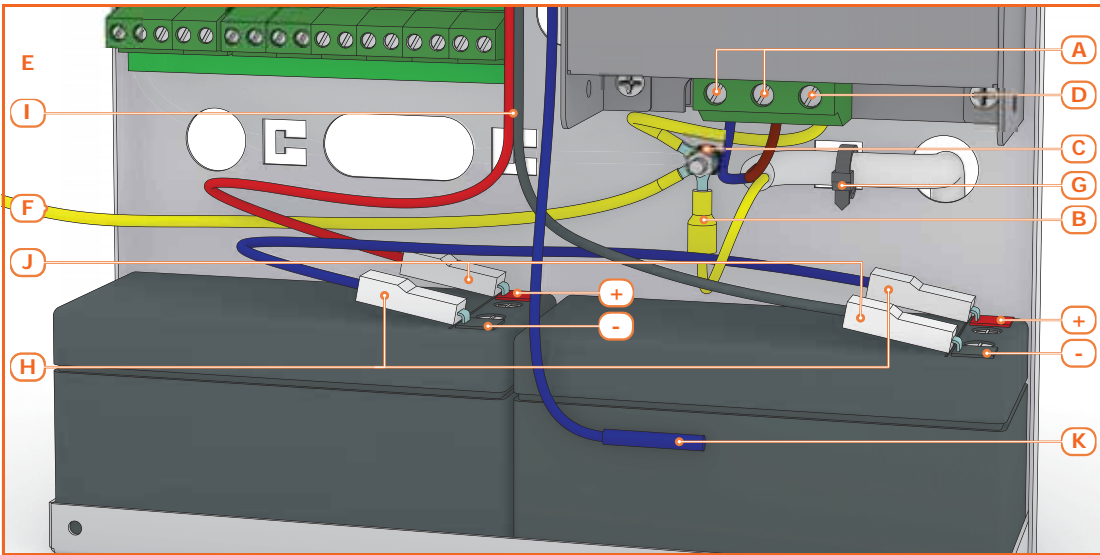

1. Connect the mains power supply to the terminals on the power-supply module ([A], table 1, K).

For a safety standards compliant system, the Line must be connected to terminal "L" and the Neutral conductor to terminal "N".

The power supply must come directly from an electrical distribution panel via a reserved line. This line must be protected by a suitable sectioning device as required by the local standards and laws in force.

The electrical system of the building must have a magneto-thermal switch as an additional protection against overcurrents and short circuits.

The end of a stranded wire must not be consolidated with soft soldering in points where the wire is subjected to contact pressure.

2. Crimp the earth line wire to the eyelet terminal [B].
3. Secure the wire with the eyelet to the control panel using the ground connection screw [C].
4. Ensure that the terminal "⏏" of the power supply module [D]], the main board [E] and the frontplate [F] are connected to Ground.

The earthing system must comply with current regulations regarding electrical safety in the systems.

A protective earth connection ensures that all exposed conductive surfaces are at the same electrical potential as the earth surface, in order to avoid the risk of electrical shock when a person touches a device in which an insulation fault has occurred. In the event of an insulation fault, a protective earth connection will generate a high fault current which in turn will trigger an overcurrent protection device (fuse) and disconnect the power supply.

5. Ensure that low-current safety or signal lines DO NOT come into contact with points with potentially dangerous currents.
Using a plastic cable tie, bunch the wires together and secure them to one of the wire hooks on the backplate of the enclosure [G].

The connection wires (to the mains supply and also any other wires inside the cabinet) must be secured to the cable hooks on the backplate by means of plastic cable ties. Use cable with double isolation for the connection to the electrical mains.

Note

ATTENTION!

To satisfy EN 54 standard requirements, when the communicator is not used with an INIM control panel, it is necessary to insert the E-FAULT jumper of the power supply.

EN54

Connecting the batteries

3-2-2

The metal enclosure of the communicator is capable of housing two 12V 1.3Ah lead batteries. The two batteries must be connected in series, in such a way as to supply 24V.

1. Place the batteries into the battery compartment inside the enclosure (*table 1, R*).
2. Using the battery wire ([H]), connect the batteries together.
3. Connect the wire coming from the power supply ([I] *table 1, M*) to the battery terminals ([D]).

Ensure that the polarity is correct.

Red - positive

Black - negative

ATTENTION!

The connection of the batteries before the mains voltage is present will not activate the system. Once the mains voltage is supplied, the power-supply module will connect the batteries automatically and initialize the circuits which manage them.

4. Position the thermal probe ([K], *table 1, N*). The thermal probe must be positioned on the side of the battery and held in place by a strip of tape.

The lead batteries provide the secondary power source that will power the F-COM and the devices connected to its outputs when the primary power source is not present.

Mounting the Antenna

3-3

1. Remove the antenna from the bag.
2. From above the enclosure, insert the antenna cable into its appropriate placement (*table 1, O*).
3. Fit the antenna in the placement adapted for network reception using the magnetic base or by attaching it to the wall by means of the two anchor screws.
4. Using the ancillary wire, connect the antenna wire to appropriate connector on the main board (*table 1, F*).

Telephone connections

3-4

Connect the PSTN line (Public Switched Telephone Network) to the "L.E." terminals. (2 and 3, *tabella 2 "Terminal board"*).

The F-COM is protected against damage caused by lightening strikes.

Note

Connect any telephone apparatus to the "L.I." terminals. (4 and 5).

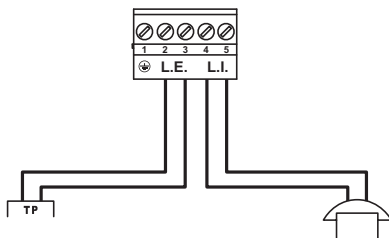

Connecting to a PC 3-5

It is necessary to connect to a PC equipped with the F-COM-STUDIO software for the programming, layout and monitoring of the system the F-COM is connected to. The connection with the PC can be achieved through a USB cable inserted into the appropriate connector on the main board (*table 1, D*).

Once the F-COM is connected, the driver for the installation of the USB device recognized by the PC is available in the F-COM-STUDIO software installation folder, specifically in the following folder (in the case of a default installation):

C:\Program Files\F-COM-STUDIO\drivers

Connecting the terminals 3-6

For the connection of the input/output terminals use:

- Use shielded cable with the necessary number of conductors
- Proper section (minimum 0.5mm², maximum 2.5 mm²)
- Compliant with local standards and laws in force

EN54

ALARM CALL and FAULT CALL 3-6-1 connection

The "ALARM CALL" and "FAULT CALL" inputs are to be used for the start communication signals relating to fire alarms and control panel faults.

These inputs can be supervised by connecting the appropriate balancing resistance, and are compatible with the communicator output on Inim fire detection panels.

The illustrated resistance values (3900 and 1000ohm) are those required when the default input threshold values are used.

Since thresholds are programmable via the software, the installer can choose the balancing resistance values.

When supervision is enabled, the occurrence of open and short-circuit conditions will generate an "Interconnection fault".

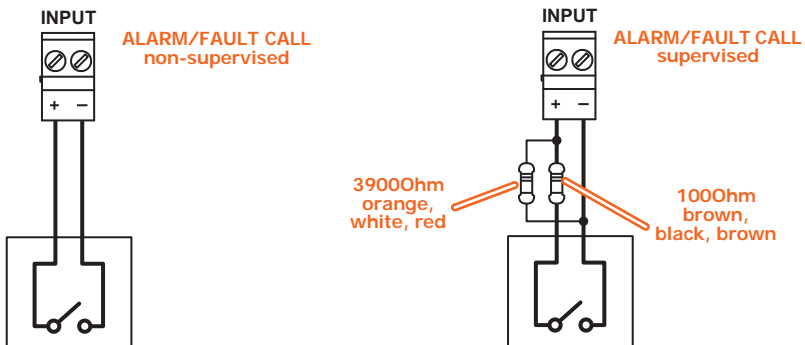

Following is the connection of the communicator with a SmartLine fire-detection control panel manufactured by Inim Electronics, for alarm and fault communications:

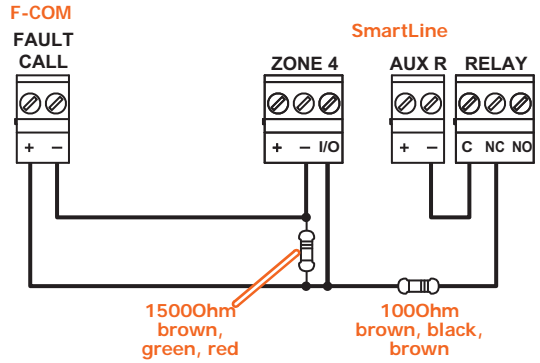
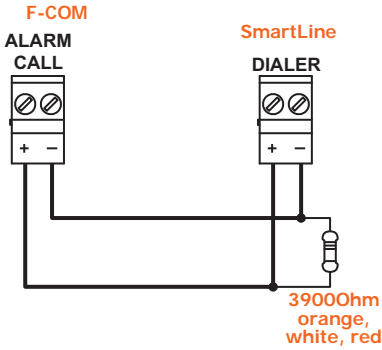

For SmartLine control panels it is necessary to enable the "Output to fault warning routing equipment" option using SmartLeague software, above version 3.5.1.6.

- Polarity:
 - Normally Open (default)
 - Normally Closed
- Supervision:
 - Enable (default)
 - Disabled
- Programmable thresholds

PROGRAMMING OPTIONS

The "ALARM CALL" terminal is an E function input for the signalling of alarms. The "FAULT CALL" terminal is a J function input for the signalling of faults. If you desire to maintain an EN54-21 standard compliant system, DO NOT disable terminal supervision.

EN54

The voltage applied to the "ALARM CALL" and "FAULT CALL" terminals must be between 0 to 3.3V=.

Connecting ALARM ACK, FAULT and OUT1 terminals

3-6-2

The three outputs, "ALARM ACK", "FAULT" and "OUT1" are open-collector outputs capable of driving maximum 150mA / 30V=.

The following wiring diagram illustrates connections for the activation of a load when an output closes to ground.

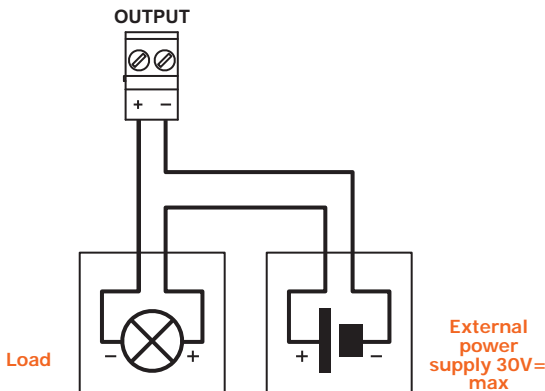

The outputs can be supervised.

The "Interconnection fault" is activated in the event of:

- open-collector output open, if the load to positive is not detected or when a short-circuit to ground is detected
- open-collector output closed, in the event of an internal fault

Table 4: Output functions

terminal	activation	deactivation
ALARM ACK	Activates each time an alarm communication is confirmed from remote: <ul style="list-style-type: none"> - in the case of a voice call when the "*" key is pressed on the telephone in use - in the case of a digital communication, on reception of the "ACK" signal 	If configured as bistable, this output is restored when the communicator is rearmed.
FAULT	Activates in the event of one or more faults: <ul style="list-style-type: none"> - interconnection fault - battery fault - no battery - power supply fault - mains failure - ground fault - programming fault - PSTN fault - SIM fault - insufficient SIM credit - mobile network fault (GSM) - mobile network data fault 	If configured as bistable, the output will restore when all the faults restore.
OUT1	Activates in response to the events configured for this output (refer to <i>Appendix A</i>). At default it activates when the "Interconnection fault" occurs.	It restores when the event configured for this output restores (refer to <i>Appendix A</i>). At default it restores when the "Interconnection fault" restores.

- Polarity
 - Normally Open (default for "ALARM ACK" and "OUT1")
 - Normally Closed (default for "FAULT")
- Supervision
 - Enabled
 - Disabled (default)
- Monostable/Bistable
- Monostable duration

"ALARM ACK" and "FAULT" cannot be programmed as monostable; "OUT1" is bistable at default.

PROGRAMMING OPTIONS

Connecting IOx terminals as inputs 3-6-3

The three terminals, "IO1", "IO2" and "IO3" are configured as inputs at default.

These terminals can be supervised by connecting the appropriate balancing resistances. The illustrated resistance values (3900 and 1000hm) are those required when the default input threshold values are used.

Since thresholds are programmable via the software, the installer can choose the balancing resistance values.

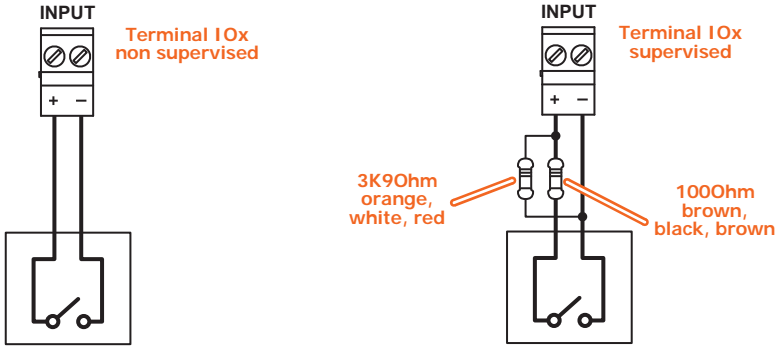

When supervision is enabled, the occurrence of open and short-circuit conditions will generate an "Interconnection fault".

Each "IOx" terminal has an internal resistor, a "pull-up" resistor, which allows to change the contact reference (to ground or positive) according to the programming.

CONTACT REFERENCE

Therefore, there are 4 ways of connecting a contact to an IOx input:

- normally-closed contact referred to ground (negative removed)
- normally-open contact referred to ground (negative applied)
- normally-closed contact referred to positive (positive removed)
- normally-open contact referred to positive (positive applied)

It is possible to associate one of the functions in the following table to each input:

Table 5: IOx functioning as input

function	input activated	note
Stop alarm communications	If the input is activated, the specified communication types will be cancelled from the call queue and any ongoing calls will be terminated.	One or more communication types can be selected. Default for terminal "IO2".
Stop fault communications		
Stop other types of communications (generic or supervision)		
Disable alarm communications	If the input is activated, the specified communication types will be disabled.	One or more communication types can be selected. Default for terminal "IO3".
Disable fault communications		
Disable other communication types (generic or monitoring)		
Force call to cellular channel	If the input is activated, it will force the communicator to use the mobile network for voice and Contact ID calls.	Forcing will have no effect if at the same moment another input configured as "Force calls to PSTN" is active.
Force calls to PSTN	If the input is activated, it will force the communicator to use the PSTN line for voice and Contact ID calls.	Forcing will have no effect if at the same moment another input configured as "Force calls to cellular channel" is active.
Rearm	Activation of the input: <ul style="list-style-type: none"> - terminates ongoing communications and cancels any communications in the call queue - switches off the "ACK" LED and yellow blinking on the "Power" LED (that indicates "System restart") - terminates audible alarm and fault signalling (on buzzer), the signalling will restart when a new alarm or fault signal event occurs - deactivates the "ALARM ACK" output - deactivates the programmable outputs ("OUT1", "IOx") 	The monostable outputs will deactivate unconditionally. For Bistable outputs, the non-restorable events will be considered "zeroed" (refer to <i>Appendix A</i>), however, in order to allow the output to be deactivated, it is necessary for all the associated events to restore. Default for terminal "IO1".

If none of the functions in the table are associated with an input, the activated actions will be those specified by events/actions programming (refer to *Appendix A*).

- Polarity:
 - Normally Open contact (default)
 - Normally Closed contact
- Supervision:
 - Enabled
 - Disabled (default)
- Contact reference
 - Ground (default)
 - Positive
- Programmable thresholds

PROGRAMMING OPTIONS

When the "IOx" terminals are programmed as inputs, the voltage applied must be between 0 and 3.3V=.

Connecting IOx as outputs 3-6-4

If set as an output, the "IOx" terminal operates as an open-collector output, capable of driving maximum 150mA / 30V=.

These terminals can be programmed to activate in the presence of events as per event/action programming (refer to *Appendix A*)

The outputs can be supervised.

The "Interconnection fault" is activated in the event of:

- open collector output open, if the load to positive is not detected or if a short circuit to ground is detected)
- open-collector output closed, in the event of an internal fault

- Polarity
 - Normally Open
 - Normally Closed
- Supervision
 - Enabled
 - Disabled
- Monostable/Bistable
- Monostable duration

PROGRAMMING OPTIONS

FIRST STARTUP

To perform a correct first startup operation, work carefully through the following steps.

During the completion of wiring, do not power the F-COM or any connected devices, neither via mains (230V a.c.) nor battery.

ATTENTION!

1. Attach the F-COM to the wall.
2. Connect the antenna.
3. Connect the input and output terminals to the fire detection system.
4. Connect the telephone line (if required).
5. Insert the SIM card (if required).
6. Connect the primary power source (230V~).
7. Connect the backup batteries.
Start the initializing phase.
8. Follow the guided programming wizard on the screen.

Guided programming (initial setup wizard)

4-1

On first startup of the communicator or restoring of factory data, the display provides the user with a fast programming guide.

By following this guided procedure and configuring at least one telephone contact, thanks to the actions programmed at default (refer to *Appendix A*), the F-COM will be able to:

- make voice calls for the activation of ALARM CALL and FAULT CALL terminals;
- send SMS texts and digital communications (Contact ID, SIA-IP, IP2RX) for the activation of ALARM CALL and FAULT CALL terminals as well as for the activation/reset of the important internal events of the communicator.

The steps of the guided procedure are:

1. Language selection: Italian or English (default)
2. Setting the date and time
3. Configuration of phone contact n.1
4. Configuration of phone contact n.2

The configuration of the contacts initially requires the type and, based on this, the parameter settings:

Table 6: Fast configuration of contacts

Contact type	Required parameters
Voice	Telephone number
	Preferential channel (PSTN or mobile)
	Supervision period
SMS	Telephone number

Table 6: Fast configuration of contacts

Contact ID	Telephone number
	Preferential channel (PSTN or mobile)
	Account code
	Supervision period
SIA-IP	IP address
	Port
	Account code
	Supervision period
IP2RX	IP address
	Port
	Account code
	Supervision period

In order to guarantee compliance with the EN 54-21 standard, supervision must be enabled and the maximum period must be 24 hours.

EN54

5. Configuration of access to the mobile data network.

The last step is implemented only when the type of one of the set contacts is SIA-IP or IP2RX. APN, username and password will be requested.

After entering this data the communication channel of the mobile data network will be enabled.

Chapter 5

USING THE COMMUNICATOR

Users 5-1

The F-COM communicator manages different access levels to the device, distinct from the system usability limitations.

Each user must have an access PIN the first digit of which characterizes the typology and cannot be changed:

Table 7: Access levels

description	permissions	access mode
Standard user	Access to the viewing of: - diagnostic information - fault details - events log	User PIN Default 000000
Advanced user	The same permissions as the standard user, plus the possibility to change some programming options relating to the contacts: - telephone numbers - communication protocol - IP address, port, account code	Advanced user PIN Default 111111
Installer	The same permissions as the standard user, plus the possibility to carry out the battery test. By means of the programming software, change all the programming options.	Installer PIN Default 222222

User interface 5-2

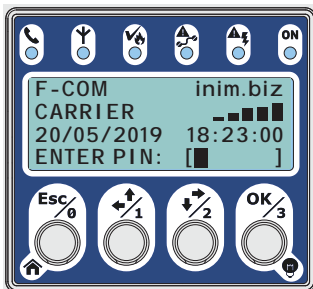

Table 8: Signalling LEDs

Icon	description	activation	signal
	Telephone line	Indicates that the communicator is engaged in an ongoing call on the PSTN channel or the presence of a PSTN fault.	<ul style="list-style-type: none"> - Flashing green, indicates an ongoing communication on the PSTN, different from an alarm communication. - Flashing red, indicates an ongoing alarm communication on the PSTN. - Solid yellow, indicates a fault on the PSTN line (line down on "L.E. terminals")

Table 8: Signalling LEDs





Icon	description	activation	signal
	Mobile network	Indicates that the communicator is engaged in a call on the mobile network or the presence of a mobile network fault.	<ul style="list-style-type: none"> - Flashing green, indicates an ongoing communication on the GSM network, different from an alarm communication. - Flashing red, indicates an ongoing alarm communication on the GSM network. - Solid yellow, indicates a fault on the mobile network: <ul style="list-style-type: none"> -Not registered to the network -No SIM -Insufficient signal -Data network connection fault -Insufficient credit
	ACK alarm	Indicates receipt or not of the confirmation of receipt of a fire alarm communication or a voice message.	<ul style="list-style-type: none"> - Solid red, indicates that an alarm communication has received confirmation of receipt. - Solid yellow, indicates that an alarm communication has not received confirmation of receipt.
	Interconnection fault	Indicates a fault in the connections with the control panel or a fault during supervision of phone contacts.	<ul style="list-style-type: none"> - Solid yellow, indicates a fault detected during supervision of the connection terminals (ALARM CALL, FAULT CALL, ALARM ACK, OUT1, FAULT, IO1, IO2, IO3) or telephone contacts.
	Power-supply fault	Signals power-supply faults and the "System restart" event.	<ul style="list-style-type: none"> - Flashing yellow, in the event of one or more faults detected by the power supply. - Flashing yellow, indicates that system restart has occurred. This signal has priority over the other.
ON	ON	Indicates that the communicator is On.	<ul style="list-style-type: none"> - Solid green, communicator functioning.

Table 9: Interface buttons





Icon	description	function
	OK	<ul style="list-style-type: none"> - Access sub-menus - Confirm entered data - If pressed on the PIN entry template, enter "3" - If pressed and held (for over 1 second), it accesses the LED test
	Right / Down	<ul style="list-style-type: none"> - Navigation menu - If pressed on the PIN entry template, enter "2"
	Left / Up	<ul style="list-style-type: none"> - Navigation menu - If pressed on the PIN entry template, enter "1"
	Esc	<ul style="list-style-type: none"> - Exit the sub-menus - Cancel the data entering - If pressed on the PIN entry template, enter "0" - Pressing and holding (for over 1 second) steps back to the main menu

Table 10: Buttons on the main board

description	function
RESET	Forces the communicator to restart.
FACTORY	Pressing for more than 5 seconds forces restoration of the programming options.

Table 11: Audible signalling from buzzer

Tone	description	signal
Reject "bop"	500Hz, 200ms	Operation on user interface rejected
Confirm "beep"	3kHz, 50ms	Operation confirmed on user interface
Alarm	2kHz On 200s Off 200s	<ul style="list-style-type: none"> It will activate upon activation of the ALARM CALL terminal. It will deactivate: <ul style="list-style-type: none"> on the pressing of OK, Esc, Up or Down on communicator rearm on receipt of an alarm ACK on restore of the ALARM CALL terminal, if the "Alarm restore follows the input" option is enabled. <p>The alarm signal has priority over the fault signal.</p>
Fault	2kHz On 1s Off 1s	<ul style="list-style-type: none"> It will activate: <ul style="list-style-type: none"> on detection of an internal communicator fault on activation of the FAULT CALL terminal It will deactivate: <ul style="list-style-type: none"> on the pressing of OK, Esc, Up or Down on communicator rearm upon restore of all internal communicator faults and the FAULT CALL terminal

The "Sound on event" option (disabled at default) enables audible alarm and fault signals on the buzzer.

The audible "confirm" or "deny" operation signals ("beep" or "bop" emitted by the buzzer) are enabled by the "Keys audio feedback" option (enabled at default).

Language used by the user interface 5-3

Table 12: Navigating on the display

Display	Conventions
<pre> INFO PROG. V.: 1 FW. V.: 1.00.00.00 SN: SNSNSNSNSNSN </pre>	<p>The line highlighted in negative (black background and white writing) indicates the current selection.</p> <p>The arrow buttons are used to move to the previous/next element.</p>
<pre> MAIN MENU FAULTS > ACTIONS > OPTIONS > </pre>	<p>An arrow pointing to the right indicates that pressing the OK button accesses a sub-menu.</p> <p>Pressing the Esc key steps back from the sub-menu.</p>
<pre> ACTIONS REARM ! STOP ALARM COM. ! STOP FAULT COM. ! </pre>	<p>An exclamation mark indicates that pressing the OK button immediately activates the selected action.</p>
<pre> OPTIONS SOUND ON EVENT [X] AUDIO FEEDBACK [X] PSTN [] </pre>	<p>The symbol in square brackets indicates the enablement of the option:</p> <ul style="list-style-type: none"> [X] option enabled [] option disabled <p>the OK button changes the status of the option.</p>

Table 13: Editable lists and fields on the display

Display	Conventions
	<p>A text in round brackets indicates a list of items. The text indicates the item.</p> <p>The highlighted text (in negative) indicates that the selected list is in edit mode.</p> <p>In this mode the arrow keys can be used to move to the previous/next item and the OK key to select the current item and exit edit mode.</p>
	<p>A text in square brackets indicates an editable field.</p> <p>The highlighted text (in negative) indicates that the editable field is selected and in edit mode.</p> <p>The highlighted character is the new character that will be entered when the OK button is pressed.</p> <p>In this mode the arrow keys can be used to select the character to be entered from a list which depends on the type of field (number, text, IP address, date/time, etc.).</p> <p>Pressing the Esc key the editable field exits the edit mode.</p>
	<p>Typically the last item in the list of characters that can be entered is an arrow to the left.</p> <p>Pressing OK when this symbol is selected deletes the last character entered.</p>

Signals on the display 5-4

During normal operating conditions of the F-COM communicator, the LCD display shows the status of the communicator and any faults.

Table 14: Signalling LEDs

Communicator status	display	line
Stand-by		<p>During stand-by conditions the communicator shows basic information:</p> <p>1° line: Product name and manufacturer</p> <p>2° line: Service provider, GSM signal strength and radio access technology:</p> <ul style="list-style-type: none"> - G) GSM / GPRS (2G / 2.5G) - E) EDGE (2.75G) - 3G: UMTS (3G) - H) HSPA (3.5G) <p>3° line: Date / Time</p> <p>4° line: Access PIN field</p>
Ongoing faults		<p>In the presence of one or more faults, the third line shows the fault description.</p>
Ongoing communication		<p>When the communicator is carrying out a communication, the respective details are shown on the display:</p> <p>1° line: Wording "EVENT COMMUNICAT:"</p> <p>2° line: Event description</p> <p>3° line: Index of telephone contact recipient of the communication</p> <p>4° line: Access PIN field</p>

When the display shows the field for PIN entry (4th line), the communicator buttons assume the enter-digit function (from 0 to 3).

Note

Main menu 5-5

Once a valid access PIN has been entered, the display shows the main menu which varies according to the level of the user:

Table 15: Main menu

Item	available for			description
	Standard user	Advanced user	Installer	
Faults	Yes	Yes	Yes	Section to view the details of eventual faults.
Actions	Yes	Yes	Yes	Section to perform the following operations: <ul style="list-style-type: none"> • Rearm the communicator • Stop alarm communications • Stop fault communications • Stop other types of communications • Forward remaining credit request • Force the battery diagnostics update This last action is available only for the installer
Options	No	Yes	Yes	Section to change the following programming options: <ul style="list-style-type: none"> • Sound on event • Key press tone • PSTN channel activation/deactivation • GSM channel activation/deactivation • Mobile data network channel activation/deactivation
Phonebook	No	Yes	Yes	Section that allows changes the most common programming options related to telephone contacts: telephone numbers (or IP address/port), preferential channel, account code.
Mobile data network	No	Yes	Yes	Section for mobile data network programming: APN, username and password
Date/Time	Yes	Yes	Yes	Section to change the date and time
Language	No	Yes	Yes	Section for language selection (concerns the user interface and default voice and SMS messages)
Change my PIN	Yes	Yes	Yes	Section to change the PIN of the logged-in user
Events log	Yes	Yes	Yes	Section to view the events log
Info	Yes	Yes	Yes	Section to view the following information: <ul style="list-style-type: none"> • Programming version • Firmware version. • Communicator serial number • GSM network diagnostics <ul style="list-style-type: none"> - Registration: home, roaming, none - Signal strength - Last credit reading • Power supply diagnostics <ul style="list-style-type: none"> - Switching power supply voltage - Output current • Battery diagnostics <ul style="list-style-type: none"> - Indication "IN CHARGE" or "IN DISCHARGE" - Battery voltage - Current absorbed or supplied by the battery

EVENTS

The events managed by the communicator are listed in the table below.

The "Events log" column indicates whether the event activation and event restored data is recorded in the events log.

The "Activate Actions" column indicates whether the communicator can be programmed to trigger an action when the event occurs.

The "Restores..." column is empty for non-resettable events.

Event	Type	Activates...	Restores...	Events log	Activate actions
ALARM CALL Input	Alarm	on activation of the ALARM CALL input	on restore of the ALARM CALL input	Yes	Yes
FAULT CALL Input	Fault	on activation of the FAULT CALL input	on restore of the FAULT CALL input	Yes	Yes
IO1 Input	Generic	on activation of input IO1	on restore of input IO1	Yes	Yes
IO2 Input	Generic	on activation of input IO2	on restore of input IO2	Yes	Yes
IO3 Input	Generic	on activation of input IO3	on restore of input IO3	Yes	Yes
Output	Generic	on activation of an output terminal	on restore of an output terminal	Yes	No
Interconnection fault	Fault	when a supervised terminal is shorted or open	when no terminal is in fault status	Yes	Yes
Battery trouble	Fault	when the battery is inefficient, discharged or short-circuited	when the battery has no problems	Yes	Yes
Missing battery	Fault	when the battery is disconnected	when the battery is connected	Yes	Yes
Power supply trouble	Fault	when the power supply is absent, overloaded or overheated	when the power supply is free of problems	Yes	Yes
Mains fault	Fault	when the mains supply fails	when the mains supply restores	Yes	Yes
Ground fault	Fault	when leakage to ground is detected	when leakage to ground is no longer detected	Yes	Yes
Data corruption	Fault	when the programming data is corrupted	when the programming data is valid	Yes	Yes
System restart	Fault	when the communicator is restarted		Yes	Yes
Rearm	Generic	when the communicator rearms		Yes	Yes
Factory default	Generic	when programming restores to factory default data		Yes	No
Programming	Generic	at the start of a programming session	on exiting a programming session	Yes	No
Changed date/time	Generic	when the communicator date/time is refreshed		Yes	Yes
PIN entered	Generic	when a user/installer PIN is recognized		Yes	Yes
Wrong PIN	Generic	when a wrong PIN is entered		Yes	Yes

Event	Type	Activates...	Restores...	Events log	Activate actions
Telephone line trouble	Fault	when the presence of the telephone line is no longer detected	when the presence of the telephone line is detected	Yes	Yes
SIM Error	Fault	when the presence of a GMS SIM is not detected	when the presence of a GMS SIM is detected	Yes	Yes
Insufficient SIM Credit	Fault	when the remaining credit is less than the programmed threshold	when the remaining credit is more than the programmed threshold	Yes	Yes
GSM trouble	Fault	when the communicator fails to connect to the GSM network or the signal is weak	when the communicator connects properly to the GSM network	Yes	Yes
Mobile data network trouble	Fault	when the SIM is not enabled for data traffic or the communicator cannot connect to the data network	when the communicator connects to the data network	Yes	Yes
Communications cancelled	Generic	when communications in progress are cancelled		Yes	No
Communications enabled/disabled	Generic	when communications are disabled	when communications are enabled	Yes	No
Communication started	Generic	at the start of a communication		Yes	No
Communication confirmed	Generic	on confirmation of receipt of a communication		Yes	No
Failed communication	Generic	when a communication is not confirmed (if the communicator is programmed to request confirmation)		Yes	No
Contact supervision trouble	Fault	when the periodic test communication is not confirmed by a supervised telephone contact	when all supervised telephone contacts confirm receipt of a communication	Yes	No
Code 0 diagnostic information	Diagnostics	when the presence of diagnostic information is detected		Yes	No
Code 1 diagnostic information	Diagnostics	when the presence of diagnostic information is detected	when the presence of diagnostic information is detected	Yes	No

Some of the events listed above have actions which are programmed at default.

Event		Output	Contacts	Voice calls	SMS text message	Contact ID event	SIA-IP/IP2RX event
ALARM CALL Input	activation	None	Contacts #1 and #2	"Fire alarm"	"Fire alarm"	110	FA
FAULT CALL Input	activation	None	Contacts #1 and #2	"Fire system trouble"	"Fire system fault"	300	FT
Interconnection fault	activation	None	Contacts #1 and #2	"Fire system trouble"	"Interconnection fault"	380	FT
Interconnection fault	activation/restore	OUT1	None	None	Empty	None	None
Battery fault	activation/restore	None	Contacts #1 and #2	None	"Battery trouble" / "Restore battery trouble"	309	YT / YR
No battery	activation/restore	None	Contacts #1 and #2	None	"Missing battery" / "Restore missing battery"	311	YM / YR
Power supply fault	activation/restore	None	Contacts #1 and #2	None	"Power supply trouble" / "Restore power supply trouble"	300	YP / YQ
Mains failure	activation/restore	None	Contacts #1 and #2	None	"Mains fault" / "Restore mains fault"	301	AT / AR
Ground fault	activation/restore	None	Contacts #1 and #2	None	"Ground fault" / "Restore ground fault"	310	UT / UR

Event		Output	Contacts	Voice calls	SMS text message	Contact ID event	SIA-IP/IP2RX event
Telephone line down	activation/ restore	None	Contacts #1 and #2	None	"Telephone line trouble" / "Restore telephone line trouble"	350	LT / LR
SIM Error	activation/ restore	None	Contacts #1 and #2	None	"SIM error" / "Restore SIM error"	350	YS / YK
Insufficient SIM Credit	activation/ restore	None	Contacts #1 and #2	None	"SIM credit low" / "Restore SIM credit low"	350	YS / YK
GSM fault	activation/ restore	None	Contacts #1 and #2	None	"GSM trouble" / "Restore GSM trouble"	350	YS / YK
Mobile data network fault	activation/ restore	None	Contacts #1 and #2	None	"Mobile data network trouble" / "Restore mobile data trouble"	350	YS / YK

SIMPLIFIED DECLARATION OF CONFORMITY

Hereby, INIM ELECTRONICS S.R.L. declares that the radio equipment type F-COM is in compliance with Directive 2014/53/EU.

The full text of the EU declaration of conformity is available at the following internet address: www.inim.biz

BG: С настоящото INIM ELECTRONICS S.R.L. декларира, че този тип радиосъоръжение F-COM е в съответствие с Директива 2014/53/ЕС.

Цялостният текст на ЕС декларацията за съответствие може да се намери на следния интернет адрес: www.inim.biz

CS: Tímto INIM ELECTRONICS S.R.L. prohlašuje, že typ rádiového zařízení F-COM je v souladu se směrnicí 2014/53/EU.

Úplné znění EU prohlášení o shodě je k dispozici na této internetové adrese: www.inim.biz

DA: Hermed erklærer INIM ELECTRONICS S.R.L., at radioudstyrstypen F-COM er i overensstemmelse med direktiv 2014/53/EU.

EU-overensstemmelseserklæringens fulde tekst kan findes på følgende internetadresse: www.inim.biz

DE: Hiermit erkläre INIM ELECTRONICS S.R.L., dass der Funkanlagentyp F-COM der Richtlinie 2014/53/EU entspricht.

Der vollständige Text der EU-Konformitätserklärung ist unter der folgenden Internetadresse verfügbar: www.inim.biz

ET: Käesolevaga deklareerib INIM ELECTRONICS S.R.L., et käesolev raadioseadme tüüp F-COM vastab direktiivi 2014/53/EL nõuetele.

Eli vastavusdeklaratsiooni täielik tekst on kättesaadav järgmisel internetiaadressil: www.inim.biz

EL: Με την παρούσα ο/η INIM ELECTRONICS S.R.L., δηλώνει ότι ο ραδιοεξοπλισμός F-COM πληροί την οδηγία 2014/53/ΕΕ.

Το πλήρες κείμενο της δήλωσης συμμόρφωσης ΕΕ διατίθεται στην ακόλουθη ιστοσελίδα στο διαδίκτυο: www.inim.biz

ES: Por la presente, INIM ELECTRONICS S.R.L. declara que el tipo de equipo radioeléctrico F-COM es conforme con la Directiva 2014/53/UE.

El texto completo de la declaración UE de conformidad está disponible en la dirección Internet siguiente: www.inim.biz

FI: INIM ELECTRONICS S.R.L. vakuuttaa, että radiolaitetyypin F-COM on direktiivin 2014/53/EU mukainen.

EU-vaatimustenmukaisuusvakuutuksen täysimittainen teksti on saatavilla seuraavassa internetosoitteessa: www.inim.biz

FR: Le soussigné, INIM ELECTRONICS S.R.L., déclare que l'équipement radioélectrique du type F-COM est conforme à la directive 2014/53/UE.

Le texte complet de la déclaration UE de conformité est disponible à l'adresse internet suivante: www.inim.biz

HR: INIM ELECTRONICS S.R.L. ovime izjavljuje da je radijska oprema tipa F-COM u skladu s Direktivom 2014/53/EU.

Cjeloviti tekst EU izjave o sukladnosti dostupan je na sljedećoj internetskoj adresi: www.inim.biz

HU: INIM ELECTRONICS S.R.L. igazolja, hogy a F-COM típusú rádióberendezés megfelel a 2014/53/EU irányelvnek.

Az EU-megfelelőségi nyilatkozat teljes szövege elérhető a következő internetes címen: www.inim.biz

LT: Aš, INIM ELECTRONICS S.R.L., patvirtinu, kad radijo įrenginių tipas F-COM atitinka Direktyvą 2014/53/ES.

Visas ES atitikties deklaracijos tekstas prieinamas šiuo interneto adresu: www.inim.biz

LV: Ar šo INIM ELECTRONICS S.R.L. deklarē, ka radioiekārta F-COM atbilst Direktīvai 2014/53/ES.

Pilns ES atbilstības deklarācijas teksts ir pieejams šādā interneta vietnē: www.inim.biz

MT: B'dan, INIM ELECTRONICS S.R.L., niddikjara li dan it-tip ta' taghmir tar-radju F-COM huwa konformi mad-Direttiva 2014/53/UE.

It-test kollu tad-dikjarazzjoni ta' konformità tal-UE huwa disponibbli f'dan l-indirizz tal-Internet li ġej: www.inim.biz

NL: Hierbij verklaar ik, INIM ELECTRONICS S.R.L., dat het type radioapparatuur F-COM conform is met Richtlijn 2014/53/EU.

De volledige tekst van de EU-conformiteitsverklaring kan worden geraadpleegd op het volgende internetadres: www.inim.biz

PL: INIM ELECTRONICS S.R.L. niniejszym oświadcza, że typ urządzenia radiowego F-COM jest zgodny z dyrektywą 2014/53/UE.

Pełny tekst deklaracji zgodności UE jest dostępny pod następującym adresem internetowym: www.inim.biz

PT: O(a) abaixo assinado(a) INIM ELECTRONICS S.R.L. declara que o presente tipo de equipamento de rádio F-COM está em conformidade com a Diretiva 2014/53/UE.

O texto integral da declaração de conformidade está disponível no seguinte endereço de Internet: www.inim.biz

RO: Prin prezenta, INIM ELECTRONICS S.R.L. declară că tipul de echipamente radio F-COM este în conformitate cu Directiva 2014/53/UE.

Textul integral al declarației UE de conformitate este disponibil la următoarea adresă internet: www.inim.biz

SK: INIM ELECTRONICS S.R.L. týmto vyhlasuje, že rádiové zariadenie typu F-COM je v súlade so smernicou 2014/53/EÚ.

Úplné EÚ vyhlásenie o zhode je k dispozícii na tejto internetovej adrese: www.inim.biz

SL: INIM ELECTRONICS S.R.L. potrjuje, da je tip radijske opreme F-COM skladen z Direktivo 2014/53/EU.

Celotno besedilo izjave EU o skladnosti je na voljo na naslednjem spletnem naslovu: www.inim.biz

SV: Härmed försäkrar INIM ELECTRONICS S.R.L. att denna typ av radioutrustning F-COM överensstämmer med direktiv 2014/53/EU. Den fullständiga texten till EU-försäkran om överensstämmelse finns på följande webbadress: www.inim.biz

**Information on electrical and electronic device disposal
(applicable in countries with recycling systems)**

The barred bin symbol found on the equipment or its box indicates that the product must be discarded separate from other waste at the end of its working life.

Therefore, the user must take the decommissioned equipment to suitable electrical and electronic waste disposal centers.

In alternative to independent management, the equipment to be discarded can be taken to the dealer upon purchase of a similar new device.

Electronic devices sized under 25 cm can be taken to electronic product dealers with at least 400 m² store surface free of charge without any purchase obligation.

Suitable collection for subsequent recycling, processing and compatible environmental disposal contributes in avoiding potential negative effects on the environment and health and promotes the reuse and/or recycling of equipment materials.

WEEE



ISO 9001 Quality Management
certified by BSI with certificate number FM530352

Via dei Lavoratori 10, Loc. Centobuchi
63076 Monteprandone (AP) ITALIA
Tel. +39 0735 705007 _ Fax +39 0735 704912

info@inim.biz _ www.inim.biz