



PRODUCT TECHNICAL DATASHEET

G30/2204

Optische encoder 
Magnetische
eindschakelaar 
230V AC 



CODE	BESCHRIJVING	STK/PALLET
G30/2204	Onomkeerbaar elektromechanische motor 230V AC, ideaal voor schuifhekken tot 2200 kg. Met ingebouwde besturingseenheid H70, optische encoder en magnetisch eindschakelaar.	30

TECHNISCHE SPECIFICATIES VAN HET PRODUCT

Gewicht	2200 kg
Stroomtoevoer	230V AC - 50Hz
Voeding motor	230V AC
Nominaal Vermogen	580W
Gebruik	50%
Motorstuwkracht	1500N
Werkings temperatuur	-20+55°C
Beschermingsfactor	IP44
Type motor	Onomkeerbaar
Cilindersnelheid	9.5 m/min (0.16 m/s)
Thermische Veiligheid	150°C
Condensator Activatie	18 µF
Eindschakelaar	Magnetisch
Controle-eenheid geïnstalleerd aan boord	H70/104AC
Encoder	Optische
Type uitgangsuitrusting	Z17/mod 4
Afmetingen (L x W x H)	346 x 180 x 362
Productgewicht verpakt (Kg)	20,7
Aantal dozen per pallet	30

AFMETINGEN

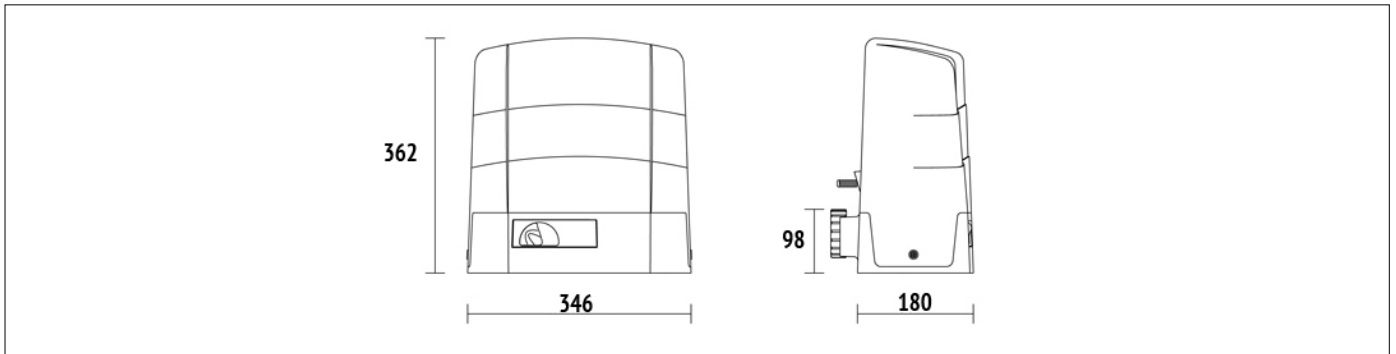

AFMETINGEN

OPSTELLING

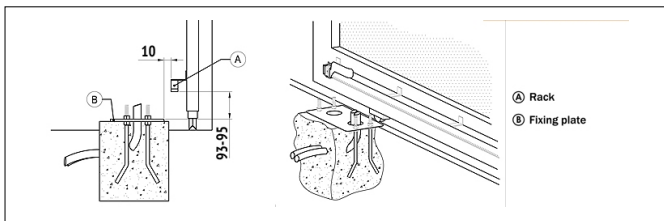

OPSTELLING VOOR STANDAARD INSTALLATIE

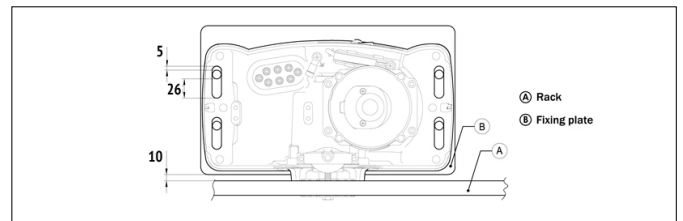

PRODUCTEN ACCESSOIRES

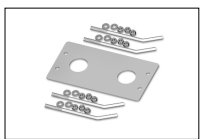

KT215
Bevestigingsplaat met steunbouten en schroeven G30 series.



KT222
Verhoogde bevestigingsplaat voor G30 series (+3,5 cm).



GA550
Gegalvaniseerde tandlat 22x22x1000 module 4.



GA551
Gegalvaniseerde tandlat 30x22x1000 module 4 met schroeven en afstandsbuizen.



GA554
Doos met 6 bevestigingen (2,5 cm) en schroeven.

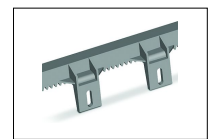

GA553
Nylon tandlat module 4 met 6 bevestigingen L.1000.



GA557
Roger Technology Nylon tandlat module 4 met 6 bevestigingen L.1000.



LT328
Tandwiel module 4 Z17 met versterking voor R30 - G30 - BG30 serie (behalve BG30/1504/HS).



LT331
Tandwiel module 6 Z11 met versterking voor G30 - BG30 serie (behalve BG30/1504/HS).

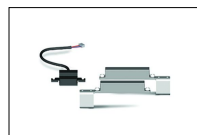

MC775
Kit magnetische eindschakelaar voor besturingseenheid H70/103AC, H70/104AC, B70/1DC, B70/1DCHP.



R99/C/001AL
Uithangbord "Opent automatisch". Aluminium versie.



R99/C/001
Uithangbord "Automatic Opening".