

QNO-6022R1

2MP IR Bullet Camera

Network



FC |  | CE | EAC

Key Features

- Maximum 2megapixel (1920 x 1080) resolution
- 0.03Lux (Color), 0Lux (B/W, IR LED on)
- 4mm fixed lens
- Maximum 30fps@2MP all resolutions (H.265/H.264)
- H.265, H.264, MJPEG codec supported, Multiple streaming
- Motion detection, Tampering, Defocus detection
- Hallway view (90°/270°), LDC support
- Micro SD/SDHC/SDXC memory slot (Max. 128GB)
- IR viewable length 25m
- IP66, IK10, PoE, 12VDC
- No-audio model

Compatible Accessories (Optional)



SBO-100B1



SBP-302PM

Video	
Imaging Device	1/2.8" 2MP CMOS
Resolution	1920x1080, 1280x960, 1280x720, 800x600, 800x448, 720x576, 720x480, 640x480, 640x360
Max. Framerate	H.265/H.264: Max. 30fps/25fps(60Hz/50Hz) MJPEG: Max. 15fps/12fps(60Hz/50Hz)
Min. Illumination	Color: 0.03Lux(F1.6, 1/30sec) BW: 0Lux(IR LED on)
Video Out	CVBS: 1.0 Vp-p / 75Ω composite, 720x480(N), 720x576(P) for installation
Lens	
Focal Length (Zoom Ratio)	4.0mm fixed focal
Max. Aperture Ratio	F1.6
Angular Field of View	H: 87.6 / V: 46.4° / D: 104.5°
Min. Object Distance	0.5m (1.64ft)
Focus Control	Fixed
Operational	
Camera Title	Displayed up to 85 characters
Day & Night	Auto(ICR)
Backlight Compensation	BLC, WDR, SSSR
Wide Dynamic Range	120dB
Digital Noise Reduction	SSNR
Motion Detection	4ea, polygonal zones
Privacy Masking	6ea, rectangular zones
Gain Control	Low / Middle / High
White Balance	ATW / AWC / Manual / Indoor / Outdoor
LDC	Support
Electronic Shutter Speed	Minimum / Maximum / Anti flicker (1/5~1/12,000sec)
Video Rotation	Flip, Mirror, Hallway view(90/270)
Analytics	Defocus detection, Directional detection, Motion detection, Enter/Exit, Tampering, Virtual line
Alarm I/O	Input 1ea / Output 1ea
Alarm Triggers	Analytics, Network disconnect, Alarm input
Alarm Events	File upload via FTP and e-mail Notification via e-mail SD/SDHC/SDXC or NAS recording at event triggers Alarm output
IR Viewable Length	25m(82.02ft)
Network	
Ethernet	RJ-45(10/100BASE-T)
Video Compression	H.265/H.264: Main/High, MJPEG
Smart Codec	WiseStream II

Bitrate Control	H.264/H.265: CBR or VBR MJPEG: VBR
Streaming	Unicast(6 users) / Multicast Multiple streaming(Up to 3 profiles)
Protocol	IPv4, IPv6, TCP/IP, UDP/IP, RTP(UDP), RTP(TCP), RTCP, RTSP, NTP, HTTP, HTTPS, SSL/TLS, DHCP, FTP, SMTP, ICMP, IGMP, SNMPv1/v2c/v3(MIB-2), ARP, DNS, DDNS, QoS, UPnP, Bonjour, LLDP
Security	HTTPS(SSL) Login Authentication Digest Login Authentication IP Address Filtering User access log 802.1X Authentication(EAP-TLS, EAP-LEAP)
Application Programming Interface	ONVIF Profile S/G/T SUNAPI(HTTP API) Wisenet open platform

General

Webpage Language	English, Korean, Chinese, French, Italian, Spanish, German, Japanese, Russian, Portuguese, Czech, Polish, Turkish, Dutch
Edge Storage	Micro SD/SDHC/SDXC 1slot 128GB
Memory	512MB RAM, 256MB Flash

Environmental & Electrical

Operating Temperature / Humidity	-30°C ~ +55°C(-22°F ~ +131°F) / Less than 90% RH * Start up should be done at above -20°C
Storage Temperature / Humidity	-30°C ~ +60°C(-22°F ~ +140°F) / Less than 90% RH
Certification	IP66, IK10
Input Voltage	PoE(IEEE802.3af, Class3), 12VDC
Power Consumption	PoE: Max 7.00W, typical 5.20W 12VDC: Max 6.10W, typical 4.50W

Mechanical

Color / Material	Dark grey / Aluminum
Product Dimensions / Weight	Ø70.0x246.0mm(Ø2.76x9.69"), 700g(1.54 lb)

DORI (EN62676-4 standard)

Detect (25PPM/ 8PPF)	40.0m(131.36ft)
Observe (63PPM/ 19PPF)	16.0m(52.54ft)
Recognize (125PPM/ 38PPF)	8.0m(26.27ft)
Identify (250PPM/ 76PPF)	4.0m(13.14ft)

- The latest product information / specification can be found at hanwha-security.com
- Design and specifications are subject to change without notice.
- Wisenet is the proprietary brand of Hanwha Techwin, formerly known as Samsung Techwin.

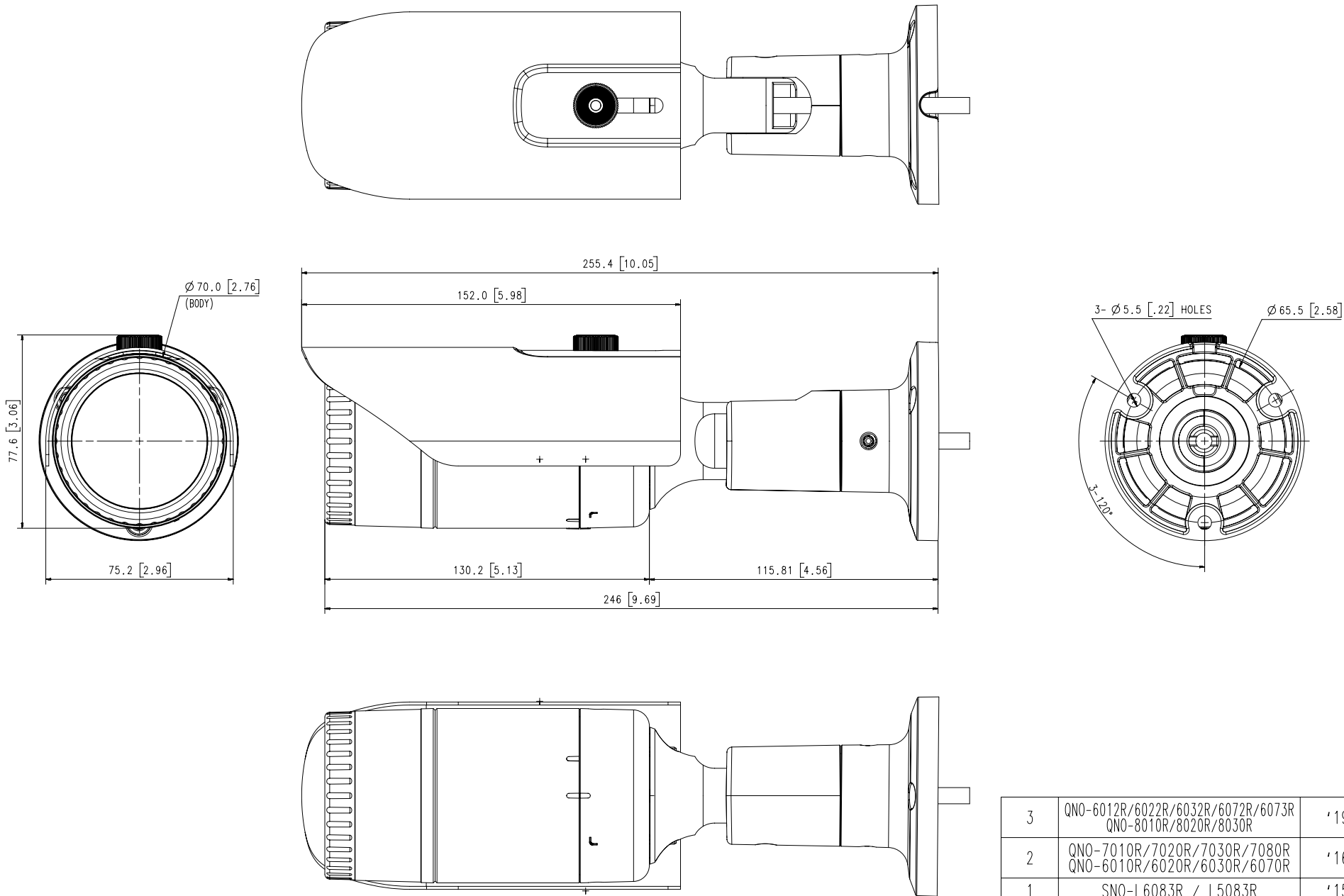

© Hanwha Techwin Co.,Ltd. All rights reserved.

3	QNO-6012R/6022R/6032R/6072R/6073R QNO-8010R/8020R/8030R	'19.04.18
2	QNO-7010R/7020R/7030R/7080R QNO-6010R/6020R/6030R/6070R	'16.05.10
1	SNO-L6083R / L5083R	'15.02.26
No.	MODEL NAME	DATE
Unit:mm[inch] SCALE:1/1		Hanwha Techwin