



2-Way Wireless Magnetic Door/Window Contact with Shutter

**Models: RWX73M, RWX73M8BL &
RWX73MBR**



CONTACTING RISCO GROUP

ITALY: Tel: +39-02-66590054

E-mail: support-it@riscogroup.com

CHINA: (Hu) Tel: +86-21-52390066

E-mail: support-cn@riscogroup.com

SPAIN: Tel: +34-91-490-2133

E-mail: support-es@riscogroup.com

ISRAEL: Tel: +972-3-963-7777

E-mail: support@riscogroup.com

USA: Tel: +1-631-719-4400

E-mail: support-usa@riscogroup.com

UK: Tel: +44-(0)-161-655-5500

E-mail: support-uk@riscogroup.com

FRANCE: Tel: +33-164-73-28-50

E-mail: support-fr@riscogroup.com

BELGIUM: Tel: +32-2522-7622

E-mail: support-be@riscogroup.com

TECHNICAL SPECIFICATION

ELECTRICAL	Battery Life: 3 years typical
Battery Type: CR123 3V Lithium Battery	Low battery: 2.6 V
Current Consumption: 11µA standby, 40 mA max	Contact Size: 32 x 35 x 72 mm (1.3 x 1.4 x 2.8 in.)
Frequency: RWX73M86800B 868.65 MHz White RWX73M8BR00B 868.65 MHz Brown RWX73M8BL00B 868.65 MHz Black RWX73M43300B 433.92 MHz White	Magnet Size: 16 x 11 x 72 mm (0.6 x 0.44 x 2.8 in.) Output power: 10mW Max.
	ENVIRONMENTAL
Dead Time (HOLD ON): 2.5 minutes	Operating temperature: -10°C – 55°C (14°F – 131°F)
Supervision Transmission: 0-255 minutes	Storage temperature: -20°C – 60°C (-4°F – 140°F)
Modulation type: ASK	RF immunity: According to EN50130-4
Specifications are subject to change without prior notice. Should any questions arise please contact your supplier.	

Figure 1

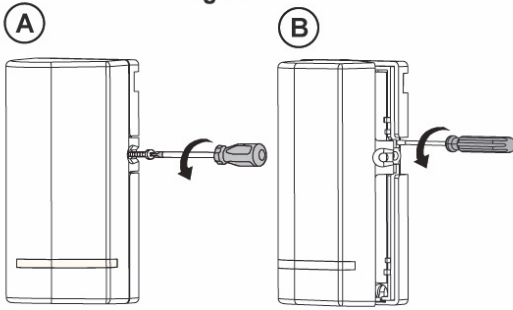

Figure 2

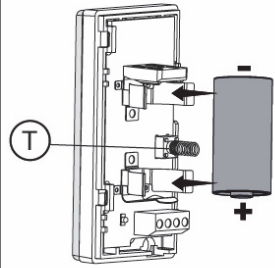

Figure 3

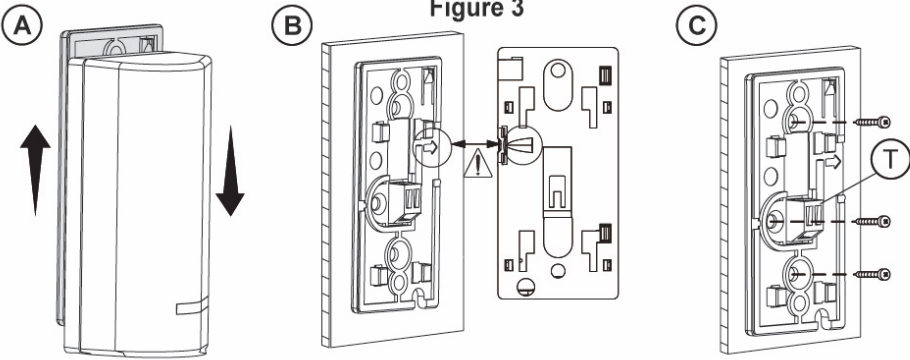

Figure 4

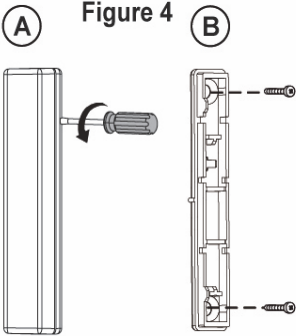

Figure 5

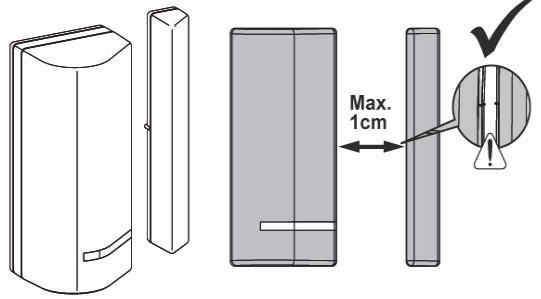

Figure 6



Optional | En option | Opzionale | Opcional | Tillval

Magnet spacers | Entretoises aimant | Distanziali per magneti |
Espaciadores de magnéticos | Distanser magnet

- RAX73MSB000A (x 10): brown | marron | marrone | marron | (brun
- RAX73MS0000A (x 10): white | blanc | bianco | blanco | vit
- RAX73MSBL00A (x 10): black | noir | nero | negro | svart

Transmitter spacers | Entretoises transmetteur | Distanziali per trasmettitori |
Espaciadores de magnéticos | Distanser sändare

- RAX73XSB000A (x 10): brown | marron | marrone | marron | (brun
- RAX73XS0000A (x 10): white | blanc | bianco | blanco | vit
- RAX73XSBL00A (x 10): black | noir | nero | negro | svart

Figure 7

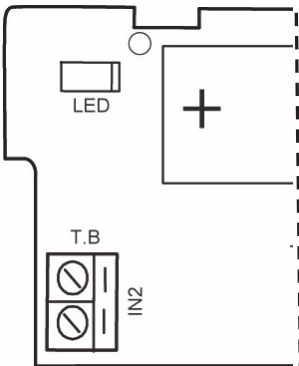
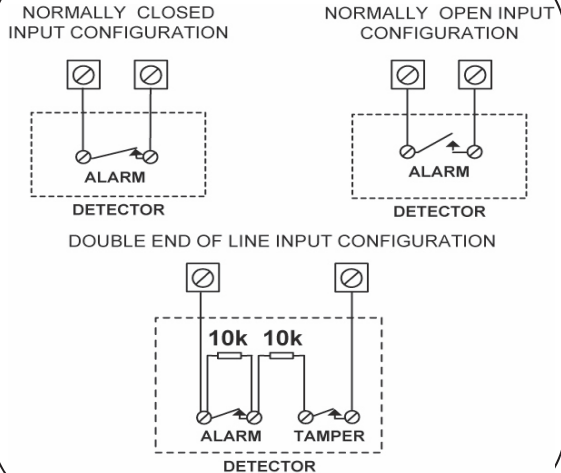

Figure 8



NOTE: Pour être en conformité avec la norme NF&A2P, seule la troisième option de câblage (DEOL) est autorisée.

GENERAL DESCRIPTION

The RWX73M is a 2-way supervised transmitter that combines the Magnetic/Door Contact (against opening doors and windows) with an additional universal input or shutter. The RWX73M operates with RISCO's 2-way wireless systems.

MAIN FEATURES

- Communication: Bi-directional
- Range: Up to 300 m (1,000 ft.) range line of sight
- Supervision: Up to 255 minutes
- Selective input termination : NO, NC, DEOL, Shutter
- Selective input response: 10 / 500ms
- Tamper protection: Back + cover

LED INDICATION

- Upon successful learning: short flash sequence
- Normal operation: brief light upon transmission
- Low battery: short flash sequence during transmission

OPERATING MODE

The RWX73M reports events from IN2 and from the magnetic reed switch. In normal operation mode, an alarm is sent when the input or magnet are triggered. When restored, it transmits a restoral message.

NOTE: If configured as Roller Shutter, the magnetic reed switch will not function.

INSTALLATION

Step 1: Transmitter-to-Receiver Communication Setup

The RWX73M must identify itself to the system's receiver by writing its coded message into the receiver's address memory. This registration is performed either by entering the RWX73M's 11-digit serial code number or by performing the following RF allocation steps:

1. Remove the front cover (Fig 1).
2. Set the main unit to Learn mode.
3. Remove battery from the insulation material and reinsert it into the transmitter, paying attention to the polarity (Fig. 2).
4. Send a write message by pressing the front tamper switch (without detaching back bracket) for at least 3 seconds until panel recognition displays (Fig. 2).

NOTE: Wait at least 1 minute before closing the front cover.

Step 2: Input Wiring

Use the diagrams for appropriate input termination wiring. For DEOL termination connect two 10K Ohm resistors (supplied). See Figure 8.

Step 3: Selecting the Mounting Location

1. Select a location for best communication quality and near the intended wired detector. It's recommended to place the unit at the highest possible position.
2. Temporarily attach the unit to this point using two-sided adhesive tape.
3. Generate an alarm signal (by momentarily opening or closing the input terminals) and verify that the receiver has received the signal. If the alarm signal is not detected, reposition the transmitter and try again.

Step 4: Mounting (Fig. 3—Fig. 6)

1. Detach back of transmitter from the back bracket (Fig. 3A). At mounting location note the alignment marks for both components (Fig. 3B), and then install accordingly using 2 mounting screws and back tamper screw (Fig 3C).

2. Detach magnet casing (Fig. 4A) and install with mounting screws (Fig 4B).
3. Optionally, mount spacer(s) for transmitter and/or magnet as required (Fig. 6), positioned between the back bracket and the mounting surface.

NOTES:

- It's best to mount the transmitter on the non-moving part (door/window frame), and the magnet on the moving part.
- Spacers are purchased separately (Figure 6).
- The mark on the magnet's case must be aligned with the mark on the transmitter's case (Fig. 5).
- For installations on wood or alloy, the maximum distance for normal operation is 10 mm (1 cm), while for metal ferromagnetic materials (such as iron) it is 5 mm (Fig. 5).

Step 5: Defining Parameters

These parameters can be defined for RWX73M:

Parameter	Option
Supervision	Yes/No
LED Enable	Yes/No
Magnet	Enable/Disable
Alarm Hold	On/Off
Termination	IN 2: NO/NC/DEOL/Shutter
Response	10ms / 500ms
Anti-sabotage magnet	--
Shutter Pulse	01–16*

* If defined

EN 50131-2-6 Grade 2 Environmental Class II

DESCRIZIONE GENERALE

RWX73M è un trasmettitore bidirezionale che include un magnete per controllare porte/finestre e in più un ingresso esterno in serie per controllare un contatto magnetico o un contatto a filo per tapparelle tramite un conteggio impulsi selezionabile integrato. RWX73M funziona con i sistemi radio bidirezionali di RISCO Group.



CARATTERISTICHE PRINCIPALI

- Comunicazione: Bidirezionale
- Portata radio: fino a 300 metri in aria libera
- Supervisione: fino a 255 minuti
- Terminazione selezionabile per l'ingresso esterno: NO, NC, DEOL, 1msec. (tapparella)
- Tempo di apertura ingresso: 10 o 500ms
- Protezione tamper: apertura e rimozione

INDICATORE LED
• Registrazione riuscita: sequenza di brevi lampeggi
• Normale funzionamento: breve accensione ad ogni trasmissione
• Batteria scarica: sequenza di brevi lampeggi durante la trasmissione

MODO DI FUNZIONAMENTO

RWX73M trasmette gli eventi generati dall'IN2 e dal contatto reed. Nella normale modalità di funzionamento l'allarme viene trasmesso quando il magnete o l'ingresso vengono attivati. Quando entrambi vengono ripristinati viene trasmessa una segnalazione di ripristino (Figure 7).

NOTA: configurando l'ingresso per contatti a filo per tapparella il reed interno verrà disabilitato.

INSTALLAZIONE

Passo 1: Registrazione del trasmettitore al ricevitore

RWX73M deve essere identificato dal sistema ricevente tramite la memorizzazione in quest'ultimo di un numero di serie.

Questa registrazione la si può effettuare inserendo manualmente nel sistema ricevente le 11 cifre del numero di serie del trasmettitore o effettuando la memorizzazione per auto-apprendimento come segue:

1. Rimuovere il coperchio frontale (Fig 1)
2. Impostare la centrale ricevente in modalità auto-apprendimento accessori radio.
3. Rimuovere la batteria dal materiale isolante e inserirla nel trasmettitore prestando attenzione alla polarità (Fig. 2).
4. Trasmettere un messaggio di indirizzo (write) premendo il tamper frontale antiapertura (senza rimuovere la base posteriore) per almeno 3 secondi fino alla conferma di ricezione da parte dell'unità ricevente (Fig.2).

NOTA: Attendere almeno un minuto prima di chiudere il coperchio frontale.

Passo 2: Cablaggio dell'ingresso

Usare gli schemi che seguono per cablare l'ingresso come richiesto. Per utilizzare una terminazione con un doppio bilanciamento resistivo (DEOL) connettere 2 resistenze da 10K Ohm (fornite) come di seguito illustrato: (Fig. 8).

Passo 3: Scegliere la posizione di installazione

1. Scegliere una posizione di installazione che garantisca una buona qualità di comunicazione e la vicinanza al dispositivo da interfacciare all'ingresso. RISCO consiglia di posizionare il dispositivo alla massima altezza possibile.
2. Fissare temporaneamente il dispositivo nel punto prescelto usando del nastro biadesivo.
3. Generare un segnale di allarme (aprendo o chiudendo momentaneamente i morsetti di ingresso) e verificare che l'unità ricevente abbia ricevuto la segnalazione. Se il segnale di allarme non viene ricevuto, riposizionare il trasmettitore e riprovare.

Passo 4: Montaggio (Fig. 3—Fig. 6)

1. Separare il trasmettitore dalla staffa di fissaggio (Fig. 3A). Nella posizione di montaggio si noti che l'allineamento è marcato su entrambi i componenti (Fig. 3B), fissare la staffa utilizzando 2 viti di fissaggio e la vite per il tamper antirimozione (Fig. 3C).
2. Separare il contenitore del magnete (Fig. A) e montarlo utilizzando le viti di fissaggio (Fig. 4B).
3. Opzionalmente, montare il distanziale/i per il trasmettitore e/o per il magnete come richiesto (Fig. 6), posizionato tra la staffa di fissaggio e la superficie di montaggio.

NOTE:

- Si raccomanda di montare il trasmettitore sulla parte non mobile (telaio della porta/finestra), e il magnete sulla parte mobile.
- I distanziali vengono forniti separatamente (Fig. 6).
- Il riferimento sull'involucro del magnete deve essere allineato con il riferimento situato sul contenitore del trasmettitore (Fig. 5).
- Per le installazioni sulle superfici di legno o in lega, la massima distanza tra magnete e reed è 10 mm. Mentre, se la superficie di installazione è in metallo o altro materiale simile (ad es. ferro), la massima distanza è 5mm (Fig. 5).

Passo 5: Configurazione dei Parametri

Il dispositivo RWX73M permette la configurazione dei seguenti parametri:

Parametro	Opzione
Supervisione	Si/No
Abilitazione LED	Si/No
Reed interno	Abilitato/Disabilitato
Inibizione trasmissioni	On/Off
Terminazione	IN 2: NO/NC/DEOL/ 1msec. (tapparella)
Risposta zona	10ms / 500ms
Impulsi tapparella	01 – 16*

* Se definito

SPECIFICHE TECNICHE

ELETTRICHE	
Assorbimento in corrente: 11µA a riposo, 40 mA max.	Modulazione: ASK Autonomia batteria: 3 anni (in funzione dell'utilizzo)
Soglia basso livello batteria: 2.6 V	Dimensioni unità: 32 x 35 x 72 mm
Tipo batteria: al litio CR123 3V	Dimensione magnete: 16 X 11 X 72 mm
Inibizione trasmissioni: 2.5 minuti	Potenza trasmessa: 10mW Max.
Frequenza: RWX73M86800B 868.65 MHz, Bianco RWX73M8BR00B 868.65 MHz, Marrone RWX73M8BL00B 868.65 MHz Nero RWX73M43300B 433.92 MHz, Bianco	AMBIENTALI Immunità RF: Conforme alla EN50130-4 Temperatura di funzionamento: da -10°C a 55°C
Trasmissione di supervisione: da 0 a 255 minuti	Temperatura di stoccaggio: da -20°C a 60°C
Le specifiche tecniche sono soggette a modifiche senza l'obbligo di preavviso. Per qualsiasi informazione fare riferimento al proprio fornitore.	

EN 50131-2-6 Grado 2 Classe ambientale II

DESCRIPTION GENERALE

Le RWX73M est un transmetteur bidirectionnel supervisé combinant un contact magnétique de portes/fenêtres et une entrée additionnelle ou obturateur. Le RWX73M fonctionne avec les récepteurs sans fil bidirectionnels du Groupe RISCO.

FR

PRINCIPALES CARACTERISTIQUES

- Communication: Bidirectionnelle
- Portée de fonctionnement jusqu'à 300 m (1000 ft) (en extérieur)
- Supervision: jusqu'à 255 minutes
- Temps de réponse de zone sélectif: 10/500ms
- Protection anti-sabotage: Arrière + Couvercle
- Terminaison de zone sélective: NO, NC, DEOL, obturateur

INDICATEUR LED

- Lors de la réussite de l'apprentissage: séquence de clignotement courte
- Fonctionnement normal: bref allumage lors de la transmission
- Pile faible: clignotement court lors de la transmission

MODE OPÉRATIONNEL

Le RWX73M rapporte les événements de l'entrée IN2 et de l'interrupteur magnétique (ILS). En mode normal de fonctionnement l'alarme est envoyée lorsque l'entrée ou l'aimant sont déclenchés. Lors d'une restauration, il transmet un message de rétablissement (Figure 7).

NOTE : Si le détecteur est défini en mode Shutter, l'aimant du contact magnétique ne fonctionnera plus.

INSTALLATION

Etape 1: Etablissement de la communication Transmetteur / Récepteur

Le transmetteur RWX73M doit s'identifier auprès du récepteur du système en inscrivant ses messages codes dans le registre d'adresses du récepteur. Cet enregistrement se fera soit en entrant le numéro de série à 11 chiffres du RWX73M ou en au moyen des étapes suivantes par allocation RF:

1. Retirez le couvercle frontal comme l'indique le schéma en fig.1
2. Réglez le récepteur en mode écriture (suivez pour cela les instructions correspondantes).
3. Retirez la pile de sa protection isolante et insérez-la dans le transmetteur en respectant la polarité indiquée (cf. fig. 2).
4. Envoyez un message d'écriture en appuyant sur le ressort d'autoprotection avant (sans détacher le support de fixation arrière) pendant au moins 3 secondes, jusqu'à ce que la centrale confirme la reconnaissance (Fig. 2).

NOTE: Attendez au moins 1 minute avant de fermer le couvercle frontal.

Etape 2: Câblage de Entrées

Utilisez les schémas ci-dessus pour le câblage de terminaison d'entrée approprié. Pour la terminaison DEOL, veuillez connecter deux résistances 10K ohms (fournies) comme illustré ci-dessous (Figure 8).

Etape 3: Choix de l'emplacement de l'installation

1. Choisissez l'emplacement le mieux adapté pour assurer la qualité de la communication, tout en restant au plus près du détecteur filaire prévu. RISCO recommande de placer l'unité en position la plus haute possible.
2. Fixez provisoirement l'appareil à ce point à l'aide d'un ruban adhésif double face.
3. Générez un signal d'alarme (en ouvrant ou en fermant momentanément les bornes d'entrée) et vérifiez que le récepteur a bien reçu le signal. Si le signal d'alarme n'est pas détecté, remplacez le transmetteur et essayez à nouveau.

Etape 4: Montage (Fig. 3 – Fig. 6)

1. Détachez la partie arrière du transmetteur du support de fixation (Fig. 3A). A l'emplacement de fixation, notez l'alignement des marques des 2 parties (Fig. 3B) et fixez en utilisant 2 vis de fixation, et une vis pour l'autoprotection (Fig. 3C).
2. Ouvrez l'aimant (Fig. 4A) et installez-le avec des vis de fixation (Fig. 4B).
3. En option, montez les entretoises du transmetteur et/ou de l'aimant si nécessaire (Fig. 6), positionnés entre le support de fixation et la surface de montage.

NOTES:

- Il est préférable de monter le transmetteur sur une partie qui ne bouge pas (cadre de fenêtre/porte), et l'aimant sur la partie qui bouge.
- Les entretoises sont commandées séparément (Fig. 6).

- La marque du boîtier de l'aimant doit être alignée à la marque du boîtier du transmetteur.
- Pour les installations sur bois, la distance maximum est de 10mm (1cm), et sur matériaux en métal (comme le fer), elle est de 5mm (Fig.5).

Etape 5: Définition des paramètres

Les paramètres suivants peuvent être définis pour le RWX73M:

Paramètre	Option
Supervision	Qui/Non
LED Validée	Qui/Non
Magnétique	Activé/Desactivé
Alarme Méorisée	On/Off
Terminaison	EN 2: NO/NC/DEOL/Obturateur
Réponse	10ms / 500ms
Impulsion Obturateur	01 – 16*

* Si define

SPECIFICATIONS TECHNIQUES

ELECTRIQUES	Type de Modulation: ASK
Type de Pile: Pile Lithium: 3V CR123	Durée de vie de la pile: 3 ans (selon usage)
Batterie Basse: 2.6V	Taille Contact: 32 x 35 x 72 mm
Consommation électrique: 11µA au repos, 40 mA max.	Taille Aimant: 16 x 11 x 72 mm
Fréquence: RWX73M86800B 868.65 MHz, Blanc RWX73M8BR00B 868.65 MHz, Marron RWX73M8BL00B 868.65 MHz Noir RWX73M43300B 433.92 MHz, Blanc	ENVIRONNEMENTALES
Temps mort (Attente): 2.5 minutes	Température de fonctionnement: -10°C – 55°C
Supervision Transmission: 0-255 minutes	Température de stockage: -20°C – 60°C
Ces spécifications sont susceptibles d'être modifiées sans avis préalable.	Immunité RF: Conforme à EN50130-4
Pour tout renseignement, veuillez contacter votre revendeur.	

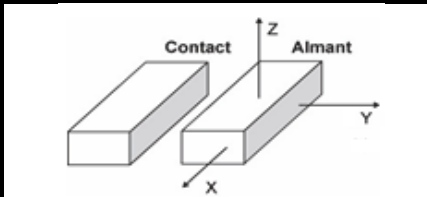
		Bois		Fer doux	
		Ouverture	Fermeture	Ouverture	Fermeture
	X	20mm	19mm	19mm	18mm
	Y	31mm	28mm	15mm	10mm
	Z	41mm	37mm	19mm	14mm
La tolérance d'omeasure est de +/- 20%					

RTC 50131-2-6, EN50131-2-6 Grade 2, Environmental Class II, IP31 IK 04

ORGANISME DE CERTIFICATION

AFNOR CERTIFICATION: 11 rue Francis de Pressensé

93571 LA PLAINE SAINT-DENIS Cedex, <http://www.marque-nf.com>

CNPP Cert: BP 2265, 27950 ST MARCEL, <http://www.cnpp.com>

Certificate number: 2122000013

NF324-H58 pour la classification 2 boucliers, et de la RTC 50131-2-6.



El RWX73M es un transmisor bidireccional supervisado que combina un contacto magnético para la protección de puertas y ventanas con una entrada universal adicional o pulsos. El RWX73M funciona con los Sistemas bidireccionales de RISCO Group.

CARACTERÍSTICAS PRINCIPALES

- Comunicación: Bidireccional.
- Alcance: Hasta 300 metros (1.000 pies) de alcance (en exterior)
- Supervisión: Hasta 255 minutos
- Tamper de protección: Trasero + Tapa
- Terminación de entrada seleccionable: NA, NC, DRFL, pulsos
- Tiempo de respuesta de entrada seleccionable: 10/500ms

INDICACIÓN DEL LED

- Una vez reconocido el transmisor: breve secuencia de parpadeo
- Funcionamiento Normal: breve encendido al transmitir
- Baja Batería: breve parpadeo intermitente durante la transmisión

MODO DE FUNCIONAMIENTO

El RWX73M envía los eventos de alarma que se producen en la entrada universal entrada 2 (IN2) y en el contacto magnético. En el modo de funcionamiento normal se envía la alarma cuando se dispara la entrada o el contacto magnético. Cuando se restaura, transmite un mensaje de restauración.

NOTA: Si se configura como detector de persiana, el interruptor de lengüeta del magnético no funcionará.

INSTALACIÓN

Paso 1: Configuración de la Comunicación Transmisor a receptor

El RWX73M debe identificarse en el receptor del sistema enviando un mensaje de escritura codificado que queda grabado en la dirección de memoria del receptor. Este registro puede realizarse introduciendo el número de serie de 11 dígitos del RWX73M o bien realizando la asignación por RF mediante los siguientes pasos:

1. Quite la tapa delantera (Fig. 1).
2. Ponga el sistema en Modo Aprendizaje.
3. Inserte la pila en el transmisor, prestando atención a la polaridad (Fig. 2).
4. Envíe un mensaje de escritura presionando el interruptor de tamper frontal (sin retirar el soporte trasero) por al menos 3 segundos hasta que se muestre el reconocimiento por parte del panel (Fig. 2).

NOTA: Espere al menos 1 minuto antes de cerrar la tapa frontal.

Paso 2: Cableado de la Entrada

Siga los siguientes diagramas para cablear correctamente la terminación de la entrada. Para la terminación con DRFL, conecte dos resistencias de 10k ohmios (suministradas) como se ilustra a Figure 8.

Paso 3: Selección de la Ubicación de Montaje

1. Elegir la ubicación más adecuada para conseguir una buena calidad de comunicación, y cerca del detector cableado (si está previsto). RISCO le recomienda ubicar la unidad a la máxima altura posible.

2. Fijar temporalmente la unidad en esa ubicación mediante cinta adhesiva de doble cara.
3. Generar una señal de Alarma (abriendo o cerrando momentáneamente el erminale de entrada) y verificar que el receptor ha recibido la señal. Si la señal de alarma no se recibe, reubicar el transmisor y probar nuevamente.

Paso 4: Montaje (Fig. 3 – Fig. 6)

1. Separe la parte trasera del transmisor del soporte trasero (Fig. 3A). En la ubicación de montaje, tenga en cuenta las marcas de alineación de ambos componentes (Fig. 3B), y luego instale de manera acorde utilizando 2 tornillos para el montaje y 1 tornillo para el tamper (Fig. 3C).
2. Separe la cubierta del magnético (Fig. 4A) e instale con tornillos de montaje (Fig. 4B)
3. Opcionalmente, monte los espaciadores para el transmisor y/o magnético según se requiera (Fig. 6), posicionados entre el soporte trasero y la superficie de montaje.

NOTAS:

- Es mejor montar el transmisor en la parte fija (puerta/marco de ventana), y el magnético en la parte con movimiento.
- Los espaciadores se venden por separado (Fig. 6).
- La marca en la cubierta del magnético debe alinearse con la marca en la cubierta del transmisor (Fig. 5).
- Para instalaciones en madera o aleación, la distancia máxima para una operación normal es 10 mm (1 cm), mientras que para materiales metálicos ferromagnéticos (como el acero) es 5 mm (Fig. 5)

Paso 5: Parámetros

Se pueden definir los siguientes parámetros en el RWX73M:

Parámetros	Opción
Supervisión	Sí / No
Habilitar LED	Sí / No
Imán-	Habilitado / Deshabilitado
Tiempo Reposo	On / Off
Terminación entrada 2 (IN2)	IN 2: NA / NC / DRFL / C. Pulsos
Respuesta	10ms / 500ms
Número de Pulsos	01 – 16*

* Si se define.

ESPECIFICACIONES TÉCNICAS

ELÉCTRICAS	Mínimo nivel de voltaje: 2.6 V
Tipo de Batería: Batería de Litio CR123 3V	Tipo de Modulación: ASK
Consumo de Corriente: 11µA en reposo, 40 mA max.	Tamaño del Contacto: 32 x 35 x 72 mm
	Tamaño del Imán: 16 x 11 x 72 mm
Frecuencia: RWX73M86800B = 868,65 MHz, Blanco RWX73M8BR00B = 868,65 MHz, Marrón RWX73M8BL00B = 868.65 MHz Negro RWX73M43300B = 433,92 MHz, Blanco	Salida de alimentación: 10mW Max.
	AMBIENTALES
	Inmunidad RF: Conforme a EN50130-4
Duración de la Batería: 3 años (dependiendo del uso)	Temperatura de Funcionamiento: -10°C a 55°C (14°F a 131°F)
Tiempo Reposo (HOLD ON): 2,5 minutos:	Temperatura de Almacenamiento:
Transmisión de Supervisión: 0-255 minutos	-20°C a 60°C (-4°F a 140°F)
Las especificaciones están sujetas a cambios sin aviso previo. En caso de duda, por favor contacte con su proveedor.	

EN 50131-2-6 Grado 2 Clase Ambiental II

ALLMÄN BESKRIVNING

RWX73M är en 2-vägs övervakad universal magnetkontakt med trådbunden ingång för extern kontakt eller rulljalusi. RWX73M är kompatibel med trådlösa 2-vägs system från RISCO

SE

HUVUDFUNKTIONER

- Kommunikation: 2-vägs
- Räckvidd: upp till 300m (3000ft) räckvidd (fri sikt)
- Övervakning: Upp till 255 minuter
- Slingbalansering: NO, NC, DEOL, rulljalusi
- Slingrespons: 10/500ms
- Sabotageskydd mot: Bortbrytning + öppning

LED-INDIKERING

- Vid lyckad inläring: kort blyxtsekvens
- Vid aktivering: tänds upp
- Lågt batteri: kort blyxtsekvens vid aktivering

DRIFTSKANALER

RWX73M detekterar status på IN1 och magnetkontaktens reed-relä. I normalt arbetsläge sänds larm vid påverkan av ingång eller magnet. Återställning sänds omedelbart när IN2 eller magnet återgår.

OBS: Om enheten konfigureras för rulljalusi kommer magnetkontakten att vara urkopplad.

INSTALLATION

Steg 1: Inläring av sändaren

X73M måste läras in till systemet innan den kan tas i bruk. Inläringen kan utföras antingen genom att manuellt ange RWX73Ms 11-siffriga serienummer eller genom att utföra automatisk inläring enligt följande steg:

1. Ta bort locket på framsidan (Fig.1)

2. Aktivera centralapparatens Inlärningsläge.
3. Sätt i batteriet i sändaren, var uppmärksam på polariteten (Fig. 2).
4. Skicka ett inlärningsmeddelande genom att hålla ner Sabotagebrytaren på kretskortet (låt monteringsplattan sitta kvar) i minst 3 sekunder till dess nlärningen bekräftas av systemet.

OBS: Vänta i minst 1 minut innan du sätter tillbaka fronten på sändaren.

Steg 2: Inkoppling av trådbunden slinga:

Följande diagram beskriver inkoppling av trådbunden slinga. För DEOL anslut två 10K ohm motstånd (medföljer). Slingan kopplas enligt följande (Fig. 8)

Steg 3: Välj monteringsplats

1. Välj dörr/fönster som magnetkontakten ska skydda. I det fall en extern trådbunden enhet ska anslutas bör sändaren placeras i närheten av enheten för att undvika onödigt långt kablage som kan ge störningar.
2. Montera enheten provisoriskt med t.ex dubbelsidig tejp eller håll helt enkelt sändaren på tänkt monteringsplats.
3. Aktivera gång-/testläge i systemet och generera en sändning genom att föra magnetdelen bort från sändaren och sedan tillbaka eller genom att sluta/bryta den trådbundna ingången. Kontrollera att signalen kommer fram. Flytta sändaren och försök igen om det inte fungerar.

Steg 4: Montera enheten (Fig. 3 – Fig. 6)

1. Separera den bakre delen av sändaren från monteringsplattan (Fig. 3A). Märk ut skruvhålen på monteringsytan (Fig. 3B), använd 3 skruv för att fästa monteringsplattan (Fig. 3C).
2. Ta isär magnetdelen (Fig. 4A) och fäst med två skruv i monteringsytan (Fig. 4B).
3. Använd eventuellt distanser för sändare och/eller magnet om detta krävs (Fig. 6), placera mellan monteringsytan och monteringsplattan.

Anmärkningar:

- Sändaren bör monteras på icke-rörlig del (dörrkarm/vägg), och magnetdelen på den rörliga delen.
- Distanser beställs separat.
- Märkningen på magnetdelens hölje ska anpassas till märkningen på sändarens hölje (Fig. 5).
- För installation på yta av .tex trä eller metall skiljer sig arbetsavstånden åt, på ferromagnetiskt material (t.ex. järn) är arbetsavståndet 5mm (Fig. 5) och på icke-magnetiskt t.ex. trä eller gips 10mm.

Steg 5: Parametrar

Följande parametrar kan definieras för varje kanal på kontrollpanelen:

These parameters can be defined for RWX73M:

Parameter	Kanal 1
Övervakning	Ja/Nej
Aktivera lysdiod	Ja/Nej
Magnet	Aktivera/Inaktivera
Batterispar	På/Av
Balansering	IN 2: NO/NC/DEOL/Rulljalusi
Responstid	10ms / 500ms
Jalusi-puls	01 – 16*

* om install

TEKNISKA SPECIFIKATIONER

ELETTRICHE	Batterlivslängd: 3 år ca
Batterityp: CR123 3V litiumbatteri	Låg nivå batteritruskelspänningen: 2.6v
Strömförbrukning: 22µA standby	Min / Max strömförbrukning: 22µA standby, 40 mA max.
Frekvens: RWX73M86800B 868.65 MHz, Vit RWX73M8BR00B 868.65 MHz, Brun RWX73M8BL00B 868.65 MHz Svart RWX73M43300B 433.92 MHz, Vit	Dimensioner magnet: 16 X 11 X 72 mm (.6 X .44 X 2.8 in.) Dimensioner sändare: 32 x 35 x 72 mm (1.3 x 1.4 x 2.8 in.) Utgångseffekt: 10mW Max.
Batterispar (inaktivitet): 2.5 minuter	AMBIENTALI
Övervakad överföring: 0-255 minuter	RF immunitet: Enligt EN50130-4 Driftstemperatur: -10°C till 55°C (14°F till 131°F)
Modulationstyp: ASK	Lagringstemperatur: -20°C till 60°C (-4°F till 140°F)
Skulle frågor uppstå, kontakta din leverantör.	

**EN 50131-2-6 Grade 2 Miljöklass II
SSF 1014 v4, & Larmklass R.**



RED COMPLIANCE STATEMENT

Hereby, RISCO Ltd. declares that this product is in compliance with the essential requirements and other relevant provisions of Directive 2014/53/EU. The declaration of conformity may be consulted at www.riscogroup.com

Dichiarazione di Conformità RED:

La sottoscritta RISCO Group, dichiara sotto la propria responsabilità che questo prodotto è conforme ai requisiti essenziali e alle altre rilevanti disposizioni della Direttiva Europea 2014/53/EU. Per le Dichiarazioni di Conformità CE, visitate il nostro sito web: www.riscogroup.com

Rapport de Conformité de RED:

Par la présente, RISCO Group, déclare cet équipement est en conformité aux conditions essentielles et à d'autres dispositions appropriées de la directive 2014/53/EU. Vous pouvez trouver la copie complète de la déclaration de conformité à la directive 2014/53/EU sur notre site web, à l'adresse suivante : www.riscogroup.com

Declaración de Conformidad RED :

Por la presente, RISCO Group declara que este equipo cumple con los requisitos esenciales y otras disposiciones relevantes de la Directiva 2014/53/EU. Para la Declaración de Conformidad CE, por favor dirijase a nuestra web: www.riscogroup.com.

RED Uttalande om uppfyllande av regler

Härmed intygar Risco Ltd. Att denna centralapparat med dess trådbundna tillbehör i all väsentlighet uppfyller kraven specificerad i Directive 2014/53/EU. CE-intyget kan inhämtas på www.riscogroup.com

STANDARD LIMITED PRODUCT WARRANTY (“LIMITED WARRANTY”)

RISCO Ltd. (“RISCO”) guarantee RISCO’s hardware products (“Products”) to be free from defects in materials and workmanship when used and stored under normal conditions and in accordance with the instructions for use supplied by RISCO, for a period of (i) 24 months from the date of delivery of the Product (the “Warranty Period”). This Limited Warranty covers the Product only within the country where the Product was originally purchased and only covers Products purchased as new.

Contact with customers only. This Limited Warranty is solely for the benefit of customers who purchased the Products directly from RISCO or from an authorized distributor of RISCO. RISCO does not warrant the Product to consumers and nothing in this Warranty obligates RISCO to accept Product returns directly from end users who purchased the Products for their own use from RISCO’s customer or from any installer of RISCO, or otherwise provide warranty or other services to any such end user directly. RISCO’s authorized distributor or installer shall handle all interactions with its end users in connection with this Limited Warranty. RISCO’s authorized distributor or installer shall make no warranties, representations, guarantees or statements to its end users or other third parties that suggest that RISCO has any warranty or service obligation to, or any contractual privity with, any recipient of a Product.

Remedies. In the event that a material defect in a Product is discovered and reported to RISCO during the Warranty Period, RISCO shall accept return of the defective Product in accordance with the below RMA procedure and, at its option, either (i) repair or have repaired the defective Product, or (ii) provide a replacement product to the customer.

Return Material Authorization. In the event that you need to return your Product for repair or replacement, RISCO will provide you with a Return Merchandise Authorization Number (RMA#) as well as return instructions. Do not return your Product without prior approval from RISCO. Any Product returned without a valid, unique RMA# will be refused and returned to the sender at the sender’s expense. The returned Product must be accompanied with a detailed description of the defect discovered (“Defect Description”) and must otherwise follow RISCO’s then-current RMA procedure published in RISCO’s website at www.riscogroup.com in connection with any such return. If RISCO determines in its reasonable discretion that any Product returned by customer conforms to the applicable warranty (“Non-Defective Product”), RISCO will notify the customer of such determination and will return the applicable Product to customer at customer’s expense. In addition, RISCO may propose and assess customer a charge for testing and examination of Non-Defective Product.

Entire Liability. The repair or replacement of Products in accordance with this Limited Warranty shall be RISCO’s entire liability and customer’s sole and exclusive remedy in case a material defect in a Product is discovered and reported as required herein. RISCO’s obligation and this Limited Warranty are contingent upon the full payment by customer for such Product and upon a proven weekly testing and examination of the Product functionality.

Limitations. This Limited Warranty is the only warranty made by RISCO with respect to the Products. The warranty is not transferable to any third party. To the maximum extent permitted by applicable law, this Limited Warranty shall not apply and will be void if: (i) the conditions set forth above are not met (including, but not limited to, full payment by customer for the Product and a proven weekly testing and examination of the Product functionality); (ii) if the Products or any part or component thereof: (a) have been subjected to improper operation or installation; (b) have been subject to neglect, abuse, willful damage, abnormal working conditions, failure to follow RISCO’s instructions (whether oral or in writing); (c) have been misused, altered, modified or repaired without RISCO’s written approval or combined with, or installed on products, or equipment of the customer or of any third party; (d) have been damaged by any factor beyond RISCO’s reasonable control such as, but not limited to, power failure, electric power surges, or unsuitable third party components and the interaction of software therewith or (e) any failure or delay in the performance of the Product attributable to any means of communication provided by any third party service provider, including, but not limited to, GSM interruptions, lack of or internet outage and/or telephony failure. BATTERIES ARE EXPLICITLY EXCLUDED FROM THE WARRANTY AND RISCO SHALL NOT BE HELD RESPONSIBLE OR LIABLE IN RELATION THERETO, AND THE ONLY WARRANTY APPLICABLE THERETO, IF ANY, IS THE BATTERY MANUFACTURER’S WARRANTY. RISCO does not install or integrate the Product in the

end user's security system and is therefore not responsible for and cannot guarantee the performance of the end user's security system which uses the Product or which the Product is a component of.

This Limited Warranty applies only to Products manufactured by or for RISCO. Further, this Limited Warranty does not apply to any software (including operating system) added to or provided with the Products or any third-party software, even if packaged or sold with the RISCO Product. Manufacturers, suppliers, or third parties other than RISCO may provide their own warranties, but RISCO, to the extent permitted by law and except as otherwise specifically set forth herein, provides its Products "AS IS". Software and applications distributed or made available by RISCO in conjunction with the Product (with or without the RISCO brand), including, but not limited to system software, as well as P2P services or any other service made available by RISCO in relation to the Product, are not covered under this Limited Warranty. Refer to the Terms of Service at: <https://riscocloud.com/ELAS/WebUI/UserLogin/License> for details of your rights and obligations with respect to the use of such applications, software or any service. RISCO does not represent that the Product may not be compromised or circumvented; that the Product will prevent any personal injury or property loss by burglary, robbery, fire or otherwise, or that the Product will in all cases provide adequate warning or protection. A properly installed and maintained alarm may only reduce the risk of a burglary, robbery or fire without warning, but it is not insurance or a guarantee that such will not occur or will not cause or lead to personal injury or property loss. CONSEQUENTLY, RISCO SHALL HAVE NO LIABILITY FOR ANY PERSONAL INJURY, PROPERTY DAMAGE OR OTHER LOSS BASED ON ANY CLAIM AT ALL INCLUDING A CLAIM THAT THE PRODUCT FAILED TO GIVE WARNING.

EXCEPT FOR THE WARRANTIES SET FORTH HEREIN, RISCO AND ITS LICENSORS HEREBY DISCLAIM ALL EXPRESS, IMPLIED OR STATUTORY, REPRESENTATIONS, WARRANTIES, GUARANTEES, AND CONDITIONS WITH REGARD TO THE PRODUCTS, INCLUDING BUT NOT LIMITED TO ANY REPRESENTATIONS, WARRANTIES, GUARANTEES, AND CONDITIONS OF MERCHANTABILITY, FITNESS FOR A PARTICULAR PURPOSE, TITLE AND WARRANTIES AGAINST HIDDEN OR LATENT DEFECTS, TO THE EXTENT PERMITTED BY LAW. WITHOUT LIMITING THE GENERALITY OF THE FOREGOING, RISCO AND ITS LICENSORS DO NOT REPRESENT OR WARRANT THAT: (i) THE OPERATION OR USE OF THE PRODUCT WILL BE TIMELY, SECURE, UNINTERRUPTED OR ERROR-FREE; (ii) THAT ANY FILES, CONTENT OR INFORMATION OF ANY KIND THAT MAY BE ACCESSED THROUGH THE PRODUCT SHALL REMAIN SECURED OR NON DAMAGED. CUSTOMER ACKNOWLEDGES THAT NEITHER RISCO NOR ITS LICENSORS CONTROL THE TRANSFER OF DATA OVER COMMUNICATIONS FACILITIES, INCLUDING THE INTERNET, GSM OR OTHER MEANS OF COMMUNICATIONS AND THAT RISCO'S PRODUCTS, MAY BE SUBJECT TO LIMITATIONS, DELAYS, AND OTHER PROBLEMS INHERENT IN THE USE OF SUCH MEANS OF COMMUNICATIONS. RISCO IS NOT RESPONSIBLE FOR ANY DELAYS, DELIVERY FAILURES, OR OTHER DAMAGE RESULTING FROM SUCH PROBLEMS. RISCO WARRANTS THAT ITS PRODUCTS DO NOT, TO THE BEST OF ITS KNOWLEDGE, INFRINGE UPON ANY PATENT, COPYRIGHT, TRADEMARK, TRADE SECRET OR OTHER INTELLECTUAL PROPERTY RIGHT IN ANY EVENT RISCO SHALL NOT BE LIABLE FOR ANY AMOUNTS REPRESENTING LOST REVENUES OR PROFITS, PUNITIVE DAMAGES, OR FOR ANY OTHER INDIRECT, SPECIAL, INCIDENTAL, OR CONSEQUENTIAL DAMAGES, EVEN IF THEY WERE FORESEEABLE OR RISCO HAS BEEN INFORMED OF THEIR POTENTIAL.

