

BOUNDARY GARD™ BX-100PLUS

Read instruction completely before beginning installation.

- Optex presents a new concept, BOUNDARYGARD™, which protects a building's exterior by detecting intruders before entry is attempted and can also provide a deterrent with its Audible Alarm Indicator before break-in occurs.
- BX-100PLUS is the Photoelectric detector which is designed with this concept. Maximum detection range between transmitter and receiver for BX-100 is 100 ft (30m).

Features

- | | |
|--|---|
| <ol style="list-style-type: none"> 1. Compact & Slim design. 2. Double Output Terminals (Individual N.O. & N.C. outputs) 3. Audible Alarm Indicator. 4. Optical alignment by Audio & Visual. 5. Tamper. 6. Option. | <ul style="list-style-type: none"> : Easily set-up on the wall. : BX-100PLUS can sound an alarm by a buzzer built in the receiver when alarm is occurring. : Easy optical alignment by Audible Alignment indicator built in the receiver & Alignment LED Indicator. : N.C. output opens when cover is removed. : White decorative cover (WC-1). White covers are to match the wall color. Hood is included which can be fixed to this cover for rain and frost proof. : Spacer (SP-1). To avoid beam interruption by obstructions : Metal Guard (MG-1). As the protector for the sensor unit not to be broken by vandalism on outdoor use. |
| <ol style="list-style-type: none"> 7. Water Proof. | <ul style="list-style-type: none"> : IP rating : IP54 |

Safety-Related Precautions

Before installation, make sure to read this instruction manual carefully for safe and effective product operation.

Warning	Caution
This icon denotes a situation involving the risk of serious injury or even death, if the warning given is ignored.	This icon denotes a situation involving the risk of serious injury or other property if the warning given is ignored.

This icon indicates actions to be avoided. Details of the actions to be avoided are written beside or near icon. (The icon on the left indicates that the product must not be dissembled)

Warning We can not assume responsibility for any damages and accidents using for any applications.	Warning Never attempt to disassemble or modify the products.
Warning Avoid the risk of connecting terminals to the units which require high power supply or current draw.	Caution Avoid directly water supplied by buckets or hose. Water splashed on the unit increases the risk of fire or electric shock.

1. PARTS IDENTIFICATION

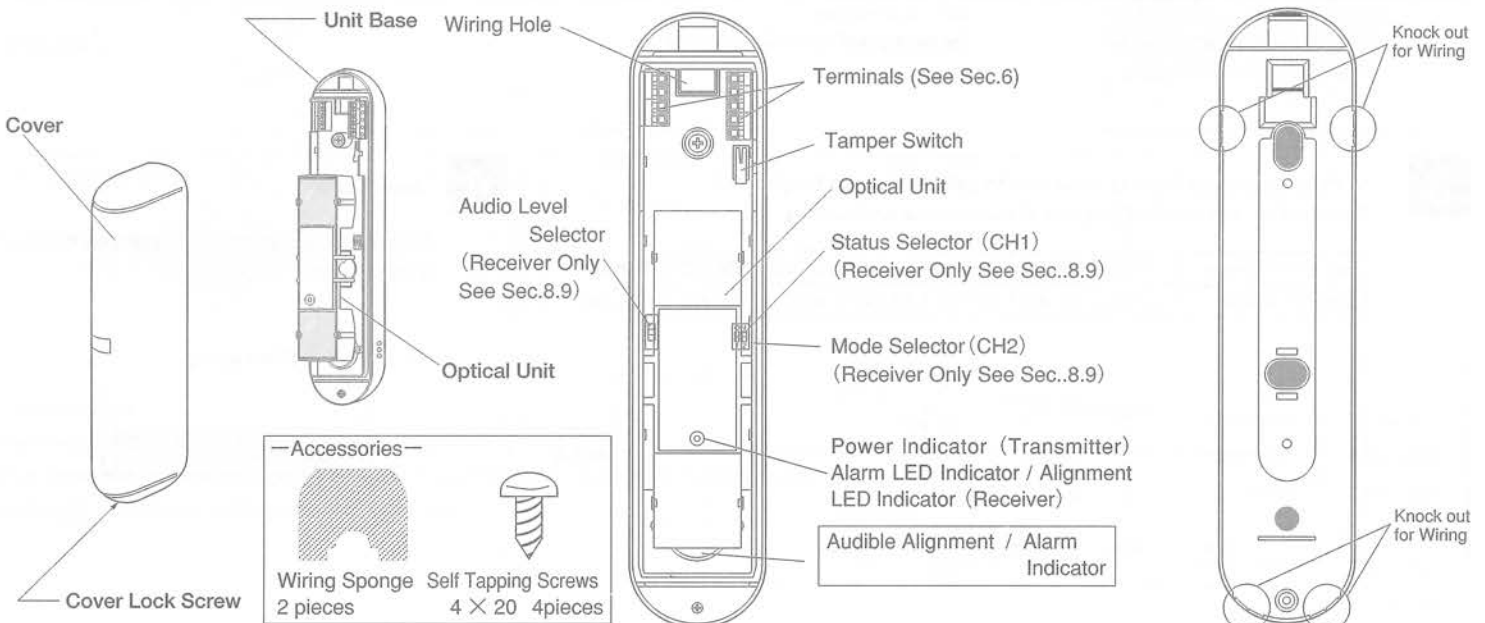

2. INSTALLATION NOTES

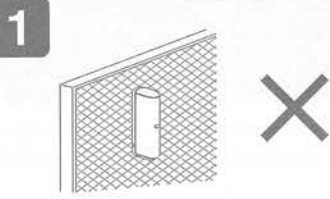

Mount unit on a solid surface only.

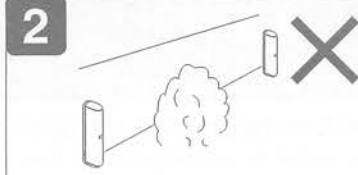

Avoid installing the unit where falling leaves or growth of branches will block the beam.

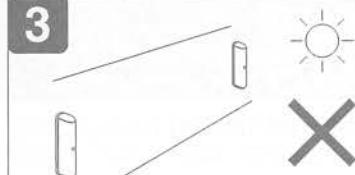

Prevent direct sunlight from entering into internal optics.

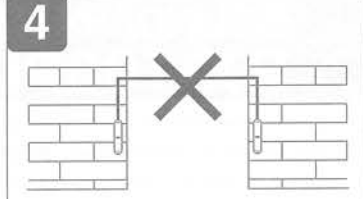

Avoid aerial wiring.

5 Line Protection

Set up Receivers and Transmitters as drawing in the case 2 sets of BX-100 PLUS will be installed not to receive the other transmitter's beam. Avoid to install 3 sets of BX-100PLUS on the line.

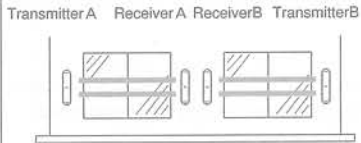

6 Beam Stacking

Set up Receivers and Transmitters as drawing. And it should be at intervals of 27" (70cm) between upper sensor and lower one.

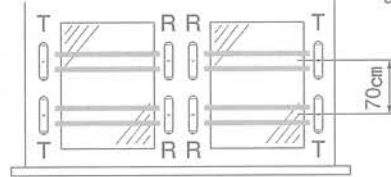

7 Perimeter Protection

Set up Receivers and Transmitters as drawing. And receivers should be at intervals of 12" (30cm) not to receive the other Transmitter's beams.

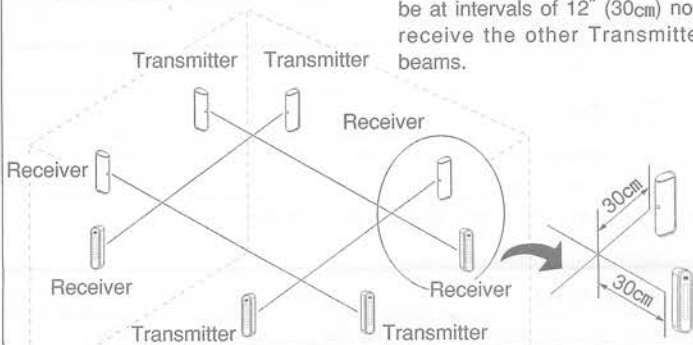

8

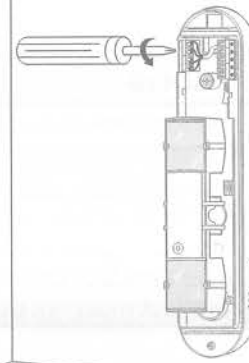

Keep appropriate space for access the terminals between the unit and the wall as drawing.

3. INSTALLATION HINTS

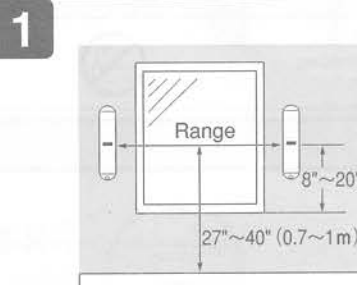

Detection range and installation height.
 Detection range.
 Maximum distance of between Receiver and Transmitter is 100 ft (30m).
 The installation height should be at 27"~40" (0.7~1 m) from ground and 8"~20" (0.2~0.5m).
 Be sure to set up at same height.

2 Alignment angle

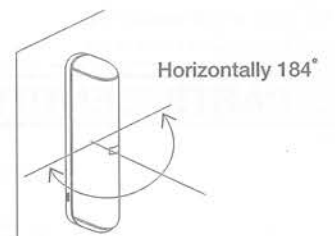

3 In the case, when there is no space to set up at same height with Transmitter, set up the Receiver in sweet area as drawing.

Detection Range	17 (5)	33 (10)	50 (15)	66 (20)	82 (25)	100 (30)	ft (m)
SWEET AREA	12 (30)	16 (40)	20 (50)	20 (50)	20 (50)	20 (50)	inch (cm)

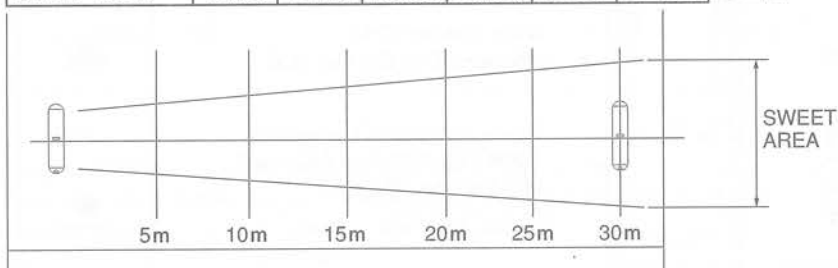

4 Front set up

Be sure to set up at same height on the vertical wall.

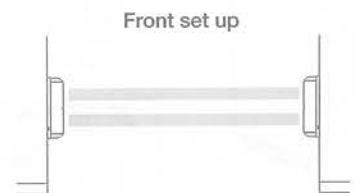

4. INSTALLATION METHOD

1



Loosen the cover lock screw and remove the front cover.

2

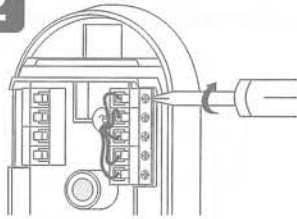

Pull out the wire through the wiring hole on the Unit Base and connect to the terminal (See Sec.6).

3

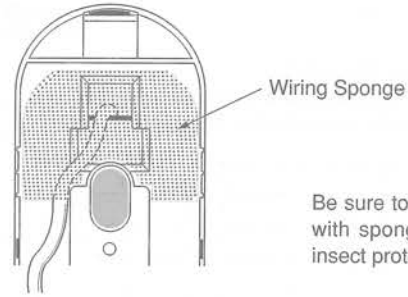

Wiring Sponge

Be sure to close the wiring hole with sponge for rain, dust and insect protection after wiring.

4

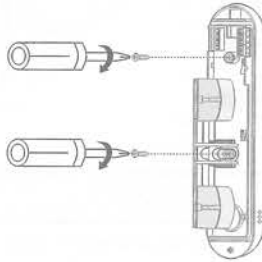

Attach the Unit Base to the wall with the screw. See Sec.5 before setting up in the case you use optional parts, white decorative cover or Spacer.

5



After checking optical alignment and operation check (See Sec.8) replace the cover, and fasten the cover lock screw tightly.

5. INSTALLATION METHOD OF WHITE DECORATIVE COVER (WC-1) & SPACER (SP-1)

White decorative cover, WC-1 are optional parts.

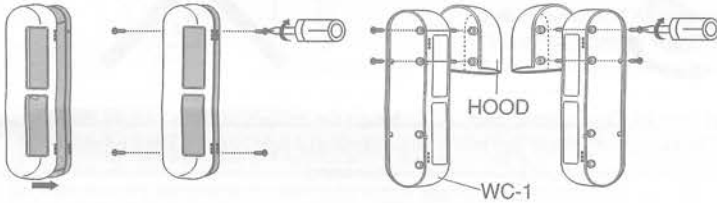

- White Decorative Cover, WC-1 is optional. Place the WC-1 on the cover of the BX-100 and tighten the provided four (4) screws through the top and bottom holes located on both sides of the unit.
- The hood which included in the package can reduce the factor of false and mis-alarm caused by rain, frost, or snow.
- Attach the hood to WC-1 with the screw as drawing.
- Then, attach WC-1 with hood to unit base as above.

Spacer, SP-1 is optional.

SP-1 allows the units to make space between the units and wall to avoid interruption by obstructions. (2 spacers can be used per unit)

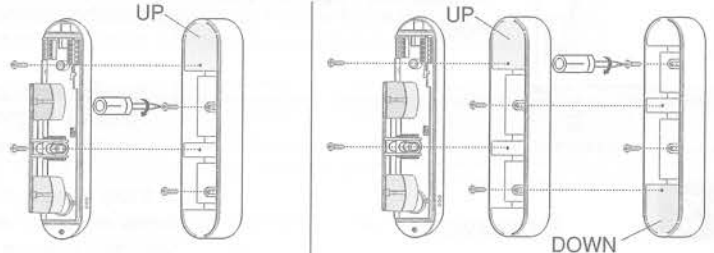

1 piece of SP-1 (50mm)
After mounting SP-1 on the wall, install the BX-100PLUS (See Sec. 4) as drawing

2 pieces of SP-1 (100mm)
After mounting SP-1 on the wall, pile up one more SP-1. Then install the BX-100PLUS (See Sec. 4) as drawing

6. TERMINAL

Receiver

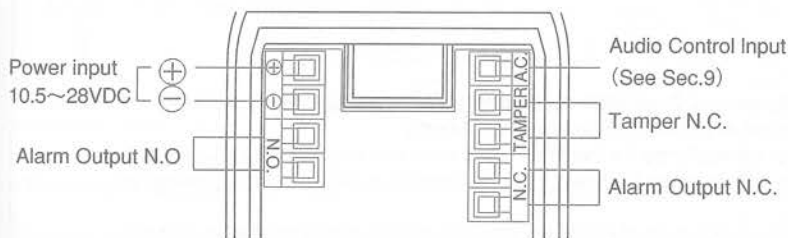

Transmitter

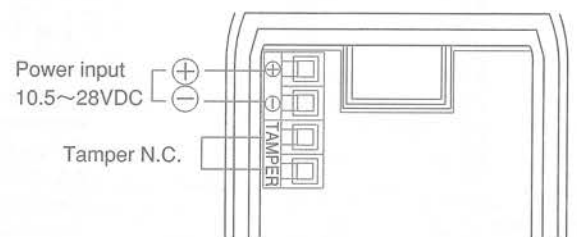

Wiring Distance

Power wires should not exceed following length.

When using two or more units on the wire, the maximum length is obtained by dividing the wire length listed below by the number of units used.

Wire Size	Power Supply	12VDC	24VDC
AWG22 (0.33mm ²)		495 (150)	1640 (500)
AWG20 (0.52mm ²)		820 (250)	2955 (900)
AWG18 (0.83mm ²)		1315 (400)	4595 (1400)
AWG16 (1.31mm ²)		1970 (600)	6565 (2000)

ft (m)

7. WIRING

Refer to the drawing

2 Set in the Line

Power unit should be parallel connected.

Alarm output should be series connected when system is N.C.

Alarm output should be parallel connected when system is N.O.

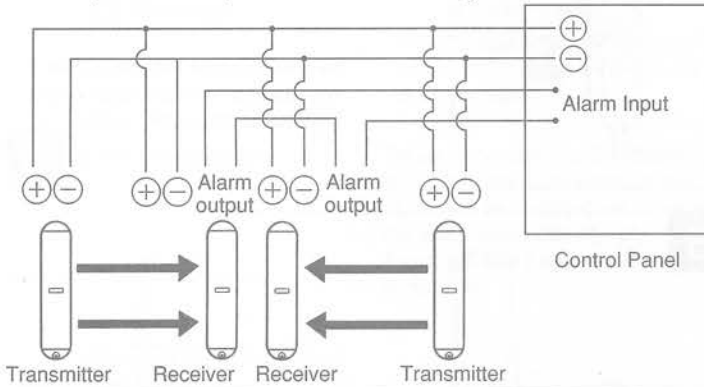

Connecting the peripheral devices

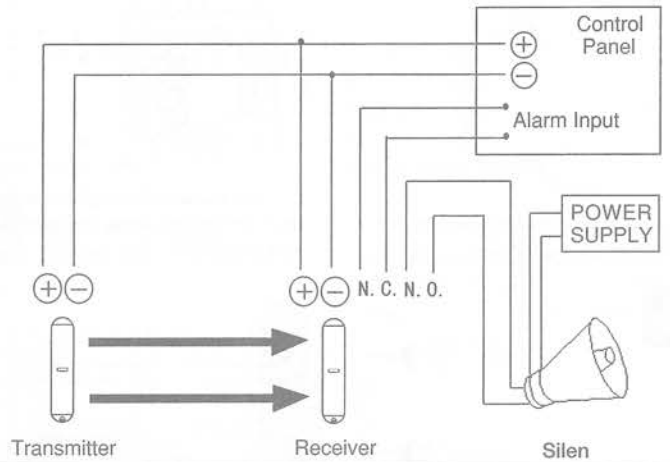

8. OPTICAL ALIGNMENT

Beams should be aligned perfectly to get reliable performance following method. The alignment should be done on condition that the cover of both Transmitter and Receiver are removed.

1 Mode Selector (CH2)

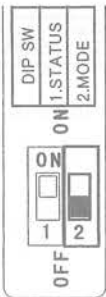

Select CH2 OFF to select Alignment Mode. This setting allows to check the Alignment Status by Audible Alignment Indicator and Alignment LED Indicator.

2



Turn the optical unit with your hand as drawing. Both optical unit of Transmitter and Receiver should be faced each other up to indicate beep sound and flickering of LED.

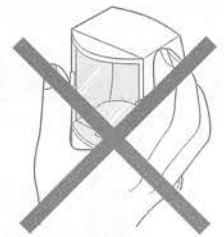

The optical unit should be adjusted not to touch the miller's surface of it as drawing indicates. Avoid breaking the beams with your hand.

3

Receiver

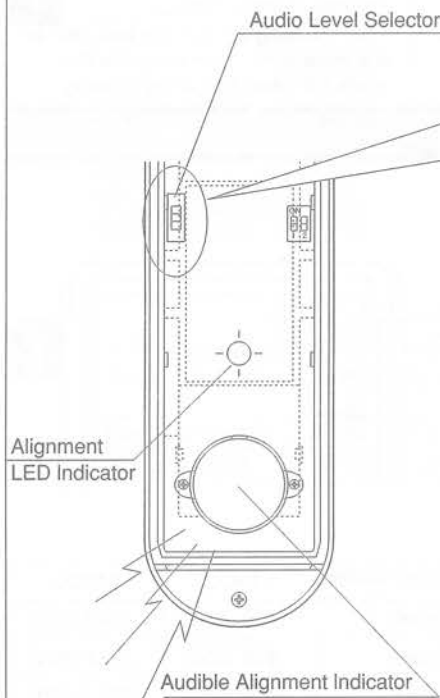

Adjust finally using Audible Alignment Indicator and Alignment LED Indicator.

① Adjust the beam alignment of Receiver until alignment status achieves Good level in Audible Alignment Indicator and Alignment LED Indicator as the following chart.

Audio Level Selector can set 3 volume level during Alignment Mode as follows.

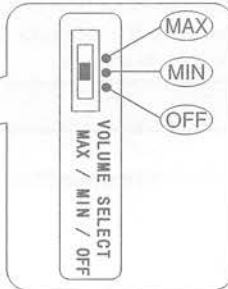

- (MAX) — Select MAX when big beep sound is required. (ex. Alignment of Transmitter)
- (MIN) — Select MIN when small beep sound is required. (ex. Alignment of Receiver)
- (OFF) — Select OFF when beep sound is not required.

② Adjust the beam alignment of Transmitter by alignment status until it achieves excellent in Audible Alignment Indicator and Alignment LED Indicator as drawing.

Optical Alignment is accomplished if it Indicates Good level after checking alignment status. If Audible Alignment Indicator and Alignment LED Indicator do not indicate Good, realign by checking ①, ②.

Should adjust the beam alignment of Receivers until alignment status achieves Excel level, Audible Alignment Indicator indicates long beeps, for reliable operation.

Alignment Level	POOR	GOOD	EXCEL
Alignment LED Indicator	Flickering Slow — — — — —> Fast	Continuously on —————>	
Audible Alignment Indicator	Pulsed tone Slow — — — — —> Fast		Continuous tone —————>

Alignment status does not achieve good level when adjusted by using suggested method.

In the case Audible Alignment Indicator do not indicate the pulsed sound and Alignment LED Indicator do not indicate light in spite of adjusting.

Check if Receiver and Transmitter are at the same height. N.G. Adjust at same height.

O.K.

Adjust the alignment up and down as follows.
 Note : it is effective when the Receiver and Transmitter was Side set up only.
 Be sure to set up at same height on the vertical wall.

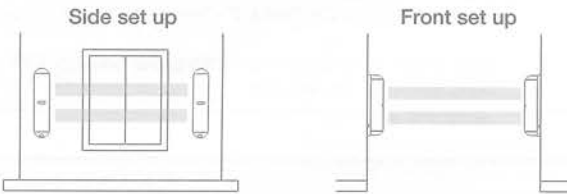

Adjustment of the alignment vertically.

The hole of base unit is large to be used for vertical adjustment. Loosen the lock screw and shift the unit base right and left, adjust the beam alignment vertically. However it is effective when the Receiver and Transmitter was Side set up only. Attach the unit at same height and mount flat surface.

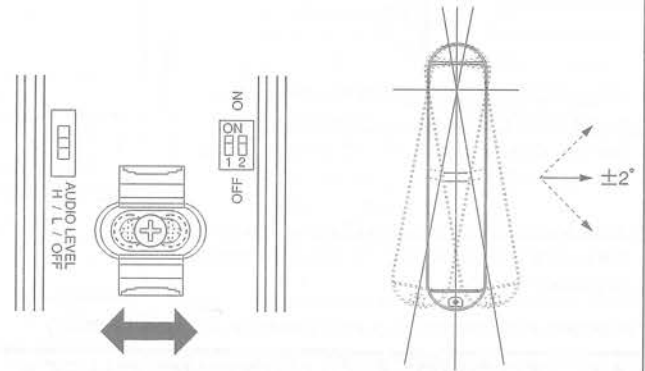

4 Mode Selector (CH2)



Alarm Mode
 ↔
 Alignment Mode

Select CH2 ON to select Alarm Mode after optical alignment when Audible Alignment Indicator indicates beep sound and Alignment LED Indicator is flickering. This setting allows Audible Alignment Indicator to switch to Audible Alarm Indicator. If Mode Selector is not selected to Alarm Mode, the beep sound of buzzer would not stop.

9. AUDIBLE ALARM INDICATOR FUNCTION

Audible Alarm Indicator is the function which warns against intruders with the beep sound (70dB) when they block the beams. This function can be controlled by program output of Control Panel. Audible Alarm Indication Function is not intended to replace the required audible sounding devices of a UL Certified Burglar Alarm System.

Status Selector (CH1)

Select CH1 ON or OFF refer to following chart.

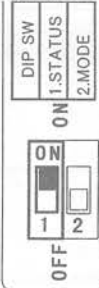

○Set the Audible Alarm Indicator to indicate beep sound only when they block the beams. This function can be controlled by program outputs of Control Panel. Select CH1 ON or OFF refer to following chart.

Alarm : Closed / Low
 ↔
 Alarm : Open / High

Detector Setting	Alarm : Closed / Low	Alarm : Open / High
CP's Status		
Arming	Closed / 0-1VDC	Open / 5-18VDC
Disarming	Open / 5-18VDC	Closed / 0-1VDC

Audio Level Selector

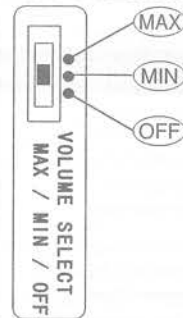

Select the Audio Level Selector MAX or MIN when the Audible Alarm Indicator is used. The volume is always MAX not to concern the setting is MAX or MIN. Select OFF when the function is not used.

< Wiring for setting the Audible Alarm Indicator only when the status of control panel is arming. >

Non-Voltage type

The switch is acquired when there is not PGM output at control panel.

- In the case there is no Non-Voltage type output on the Control Panel.
- In the case there is Non-Voltage type output on the Control Panel.

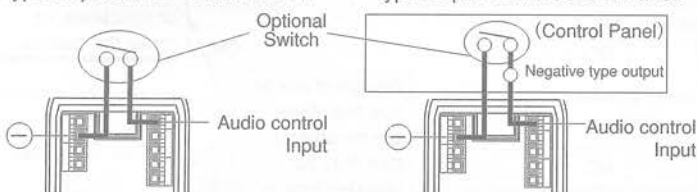

Voltage type

The switch is acquired when there is PGM output at control panel. Connect BX-100PLUS to control panel as drawing.

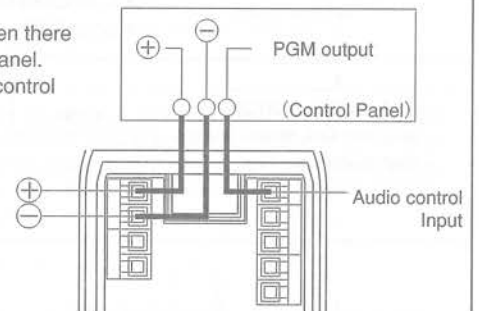

In the case Audio Control output is not connected, select the Status Selector (CH1) as follows. Select CH1 OFF when Audible Alarm Indicator is acquired. Select CH1 ON when Audible Alarm Indicator is not acquired.

10. CONFIRMATION OF ACTION

Be sure to confirm after installing.

Alarm LED Indicator

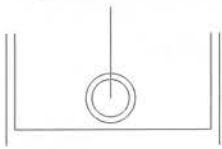

Select the Mode Selector (CH2) ON to select Alarm Mode for conducting a walk test. (See Sec 9). Check that Alarm LED Indicator of the Receiver is OFF.

If the Alarm LED Indicator is ON even though the beams are not blocked, re-adjust the optical alignment (See Sec. 8).

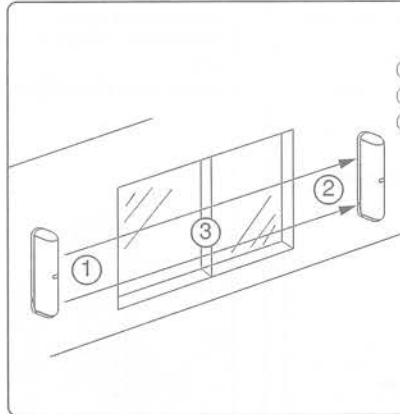

After replacing the cover of both transmitter and receiver, conduct a walk test from at least the following three points.

- ① In front of Transmitter.
- ② In front of Receiver.
- ③ At the middle point of between Receiver and Transmitter.

Installation is accomplished after checking the Audible Alarm Indicator indicates beep sound when the beams are blocked.

If the Audible Alarm Indicator does not indicate beep sound even though the beams are blocked, re-adjust the optical alignment (See Sec. 8) or refer to the following "TROUBLE SHOOTING CHECK SHEET" (See Sec 11) and follow them.

After a walk test, select the Audio Level Selector OFF when beep sound is not required.

Walk test and cleaning the covers should be conducted annually.

11. TROUBLE SHOOTING CHECK SHEET

When defective conditions are encountered, proceed with the following.
If you have any questions on these procedures, call Technical Support.

1. "No Action" on the transmitter or receiver after power has been applied.

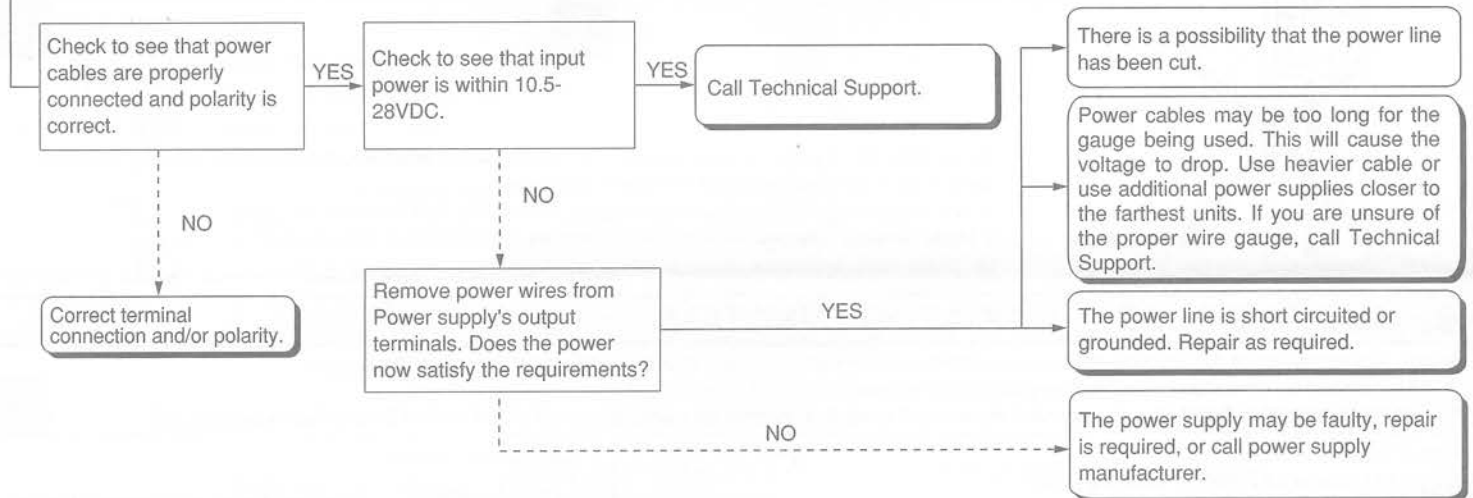

2. Alarm signal is being generated or the Audible Alarm Indicator does not stop even though beams are not blocked

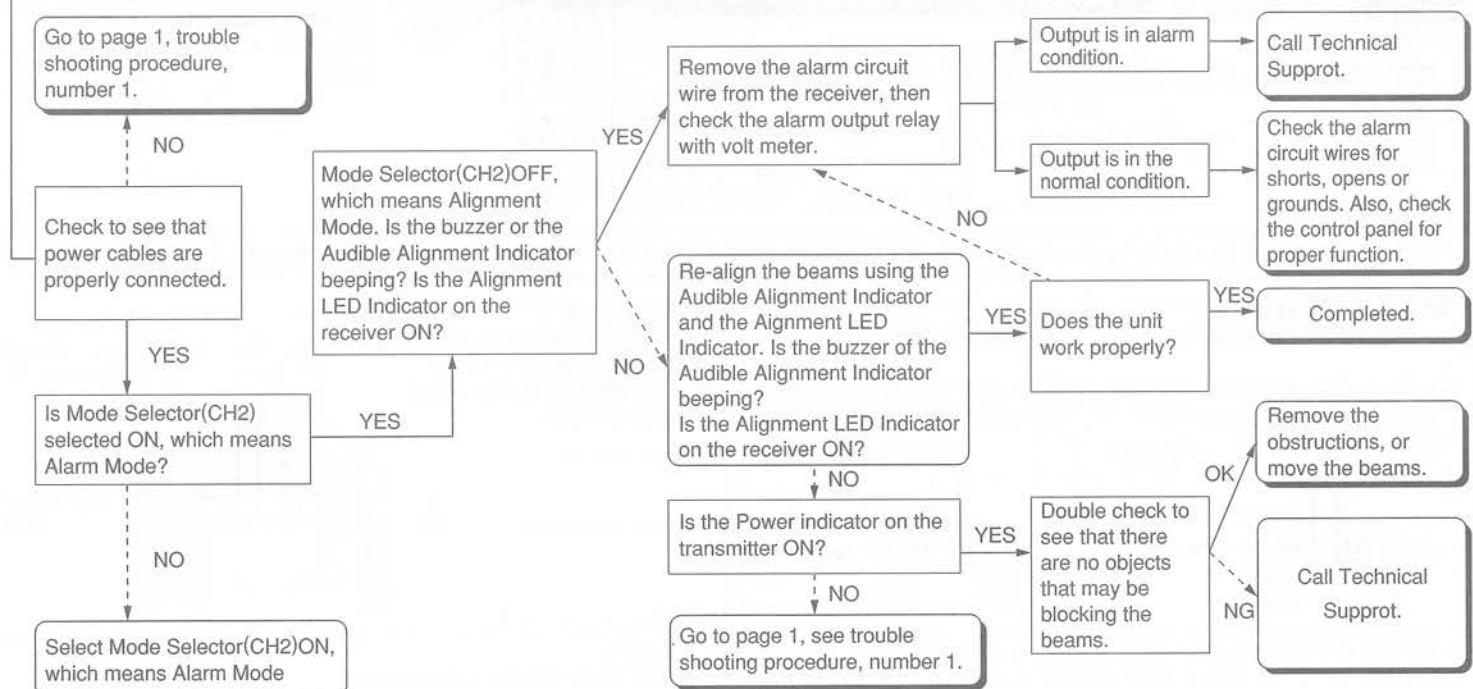

3. "No Action" on alarm zone even though the beams are blocked.

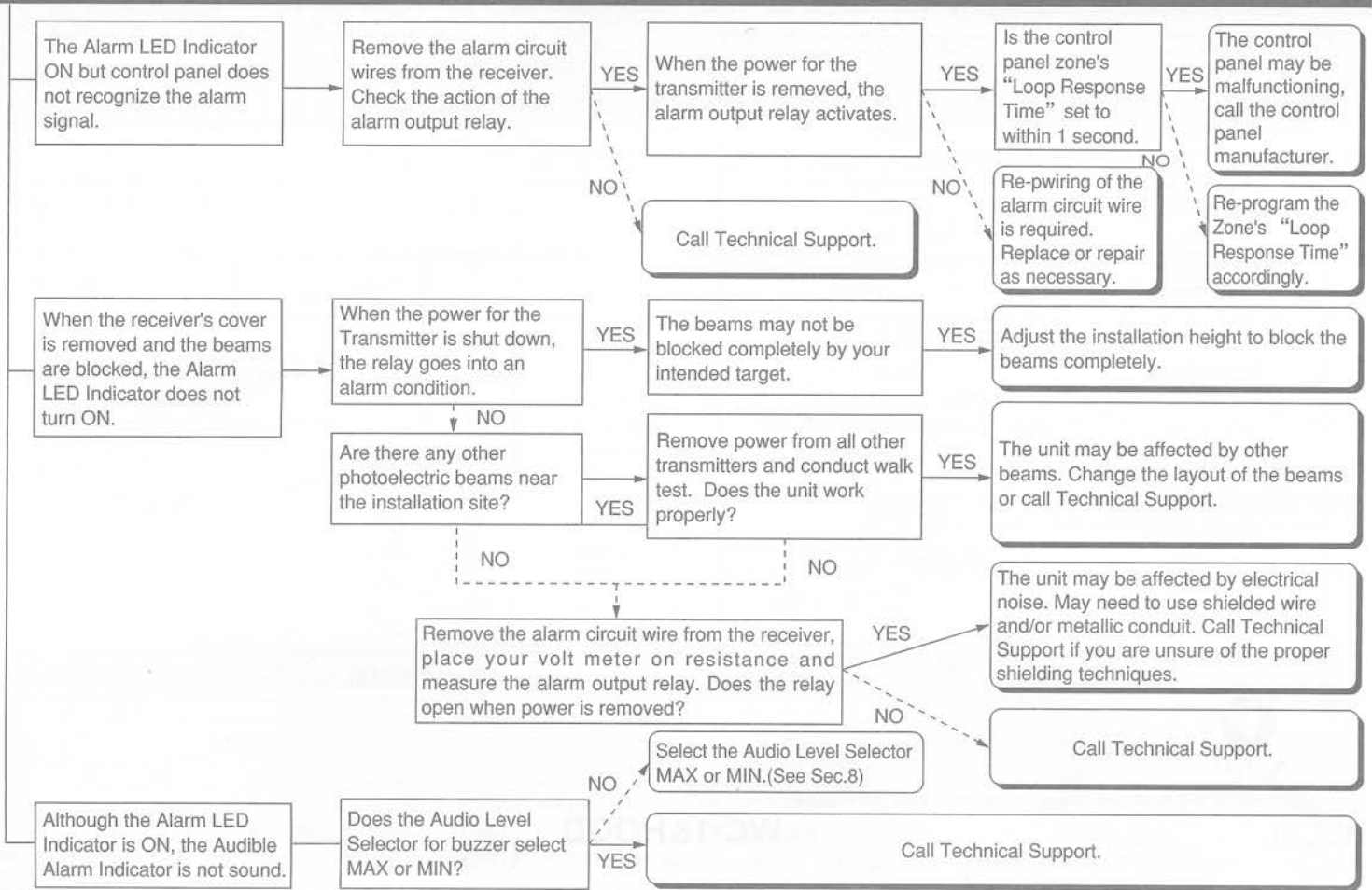

4. False activation

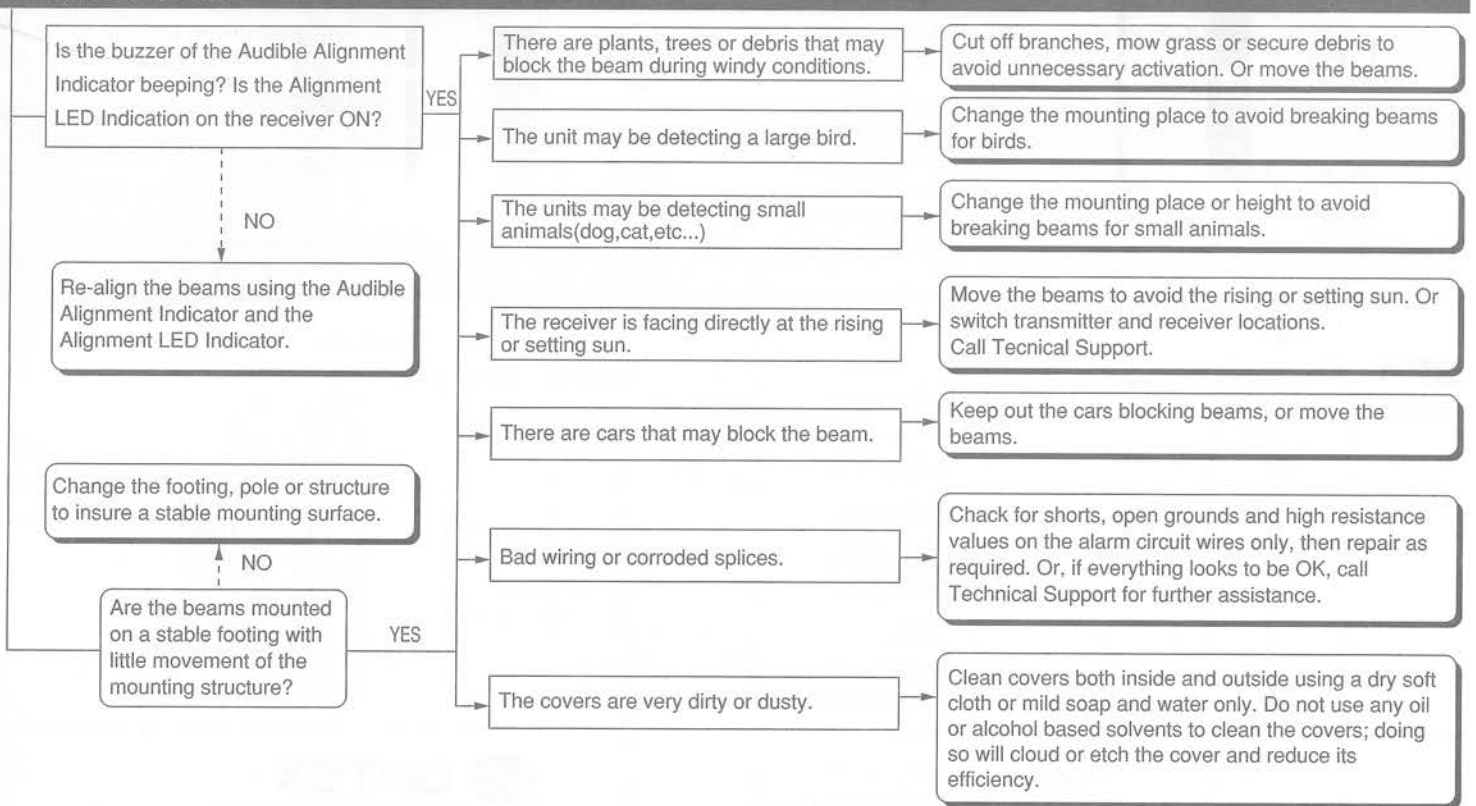

Important

The majority of false activation can be attributed to poor beam alignment. Should adjust the beam alignment until alignment status achieves "Good" level.

12. SPECIFICATIONS

Model	BX-100PLUS
Range	Outdoor 100ft.(30m) Indoor 200ft.(60m)
Maximum Arrival Distance	1000ft.(300m)
Detection Method	Simultaneous interruption of 2 infrared beams
Beam Characteristics	Pulsed Infrared
Interruption Period	50msec
Power Input	10.5 - 28VDC
Current Draw	55mA(Stand by)/ 75mA (Max)
Alarm Period	2±1 sec (Delay)
Relay Output	2 relay outputs N.O.and N.C. 28VDC 0.2A(Max)each
Beeping Period	15 sec
Volume of Audible Alarm Indicator	70dB(at 1 meter distance)
Tamper	N.C. opens when cover is removed 28VDC 0.2A(Max)
Operating Temperature	-30° F~+131° F(-35°C~+55°C)
Environmental Humidity	95 % (Max)
Alignment Angle	±92 Horizontal
Mounting	Wall(indoor / outdoor)
Weight	14.1oz(400g)
IP rating	IP54
Accessories	Self Tapping Screws x4 Wiring Sponges x2



N219

Specification and design are subject to change without prior notice.

WC-1

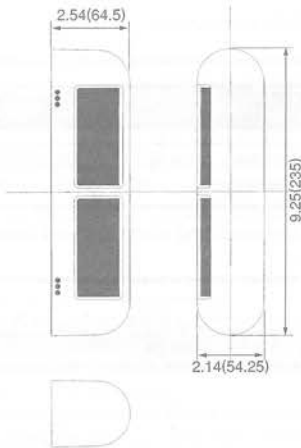

WC-1&HOOD

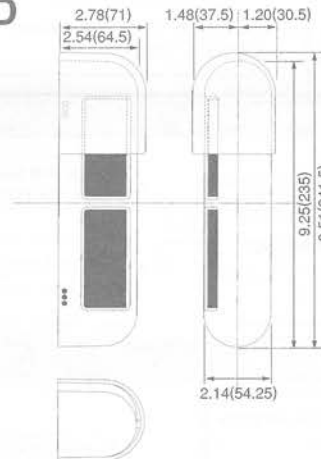

SP-1

1piece

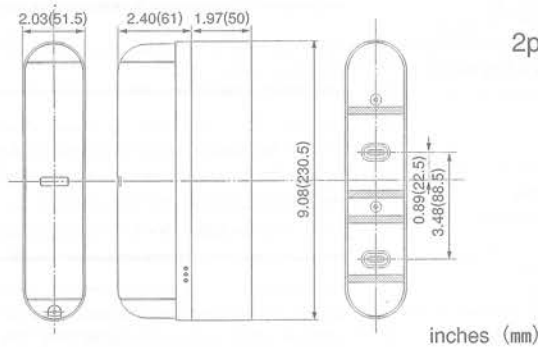

2pieces

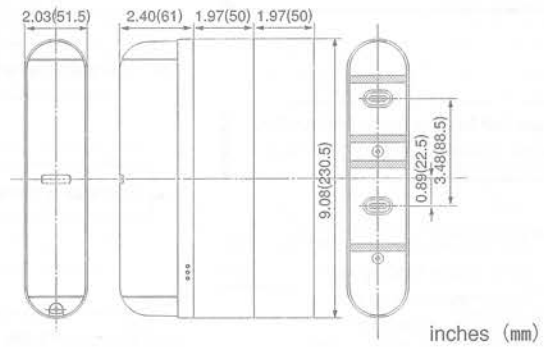

13. DIMENSIONS

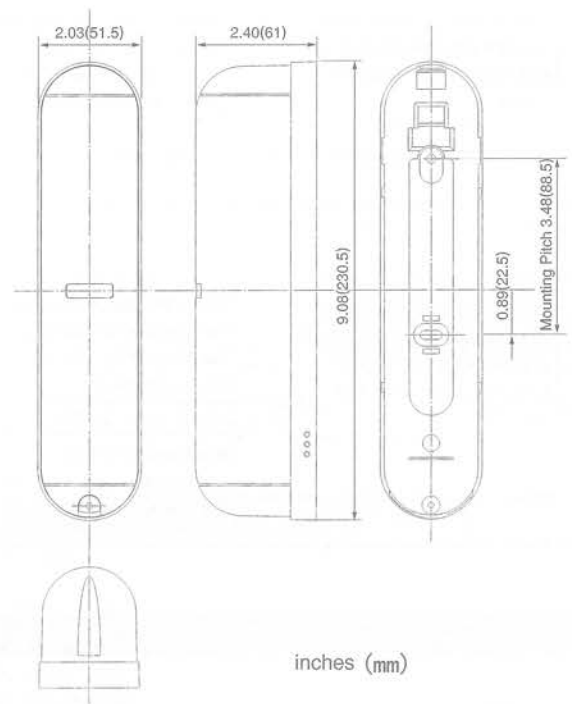

inches (mm)

NOTE

This unit is designed to detect an intruder and activate an alarm control panel. Being only a part of complete system, we can not accept responsibility for any damages or other consequences resulting from an intrusion.



OPTEX CO., LTD. (JAPAN)
 (ISO 9001 Certified by LRQA)
 (ISO 14001 Certified by JET)
 5-8-12 Ogino Otsu
 Shiga 520-0101
 JAPAN
 TEL:+81-77-579-3670
 FAX:+81-77-579-8190
 URL:http://www.optex.co.jp/en/

OPTEX INCORPORATED (USA)
 TEL:+1-209-993-5770
 Tech:(800)866-7839
 URL:http://www.optexamerica.com

OPTEX [EUROPE] LTD. (UK)
 TEL:+44-1628-831000
 URL:http://www.optex-europe.com