

Beyond™ Wireless DT

Beyond™ Wireless DT Camera

Installation Instructions



Model: RWX350DC, RWX350D

EN

FR

ES

IT

PR

For more information about RISCO Group's branches, distributors and full product line, please visit riscogroup.com

Language **Page**

EN

3

FR

13

ES

23

IT

33

PR

43

Description

The Beyond™ DT is a battery powered wireless DT detector that includes an integrated camera (in model RWX350DC) for visual verification and has been designed to provide enhanced 24-hour outdoor protection, with Active IR Anti-mask capabilities. Integrated Dual Technology (DT) combines two K-band microwave channels with two PIR sensors for better catch performance and pet immunity, minimizing false alarm.

Features include

- PIR coverage: 12m, 90°
- VGA or QVGA camera resolution with ~90° field-of-view*
- Two channel K band - MW detection (**Sway Recognition**)
- Pet immunity
- Two correlated PIR Sensors
- Light sensor for reducing false alarms due to sunlight
- Active IR Anti mask
- Various mounting heights with optional swivel bracket
- Designed for outdoor installation, UV resistant, IP 65
- Cover and wall tampers
- 3-axis-accelerometer for protection against vandalism
- Solar swivel for increased battery life (6+ years typically): RWX350S (optional)

Installation

Step 1: Preliminary Considerations

Select the mounting location for best coverage of the area that is to be protected (see Step 2: Coverage Patterns). Pay attention to the following:

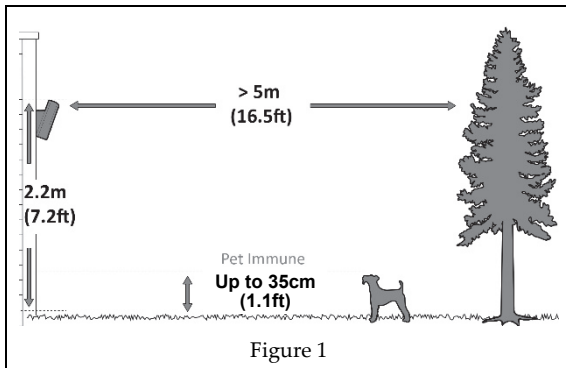

* Applicable to RWX350DC model

Install the device in a location where the detector's field of view is clear of any static obstacle

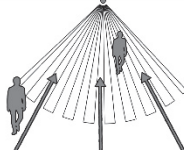
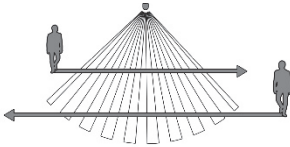

Figure 2

Walking direction must cut across the beam pattern

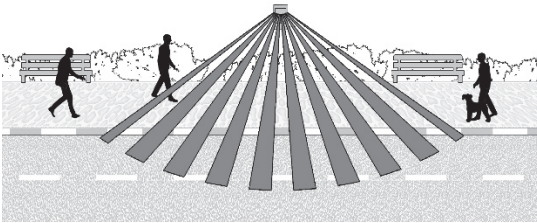
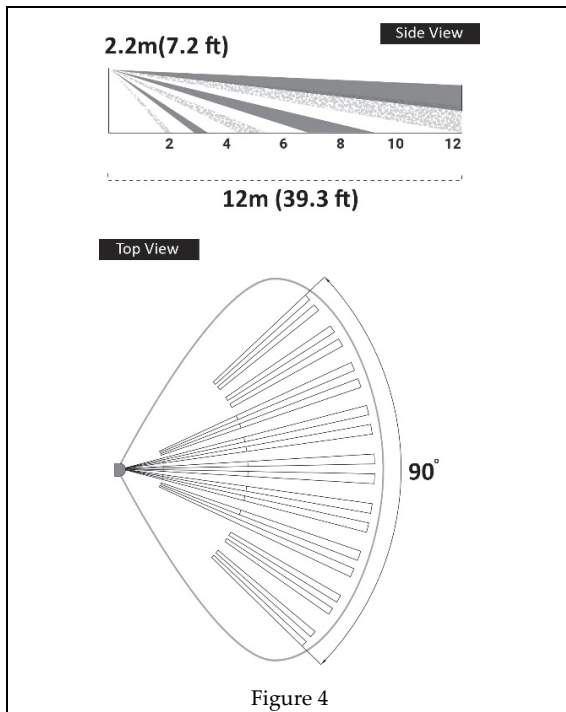

Figure 3

Do not install the device close to any moving objects

Step 2: Coverage Patterns



Step 3: Coverage

PIR Coverage

Mounting height [m]	Distance [m]
1.8	10
2.2 (optimal)	12

Note For pet immunity, install the detector at the optimal height of 2.2 meters.

PIR Coverage - Using Swivel

Note The table below is relevant when using the Swivel/Solar Swivel Bracket (Model: RA350S).

Mounting height [m]	Swivel Angle [°]	Distance [m]
1.8	0	10
	5	7
	10	5
2.2 (optimal)	0	12
	5	8
	10	6
2.5 – 2.7	0	N/A
	5	10
	10	7

NA = Avoid such installation

Step 4: Registering the Detector into the System

The detector must identify itself to the system receiver in a device allocation (enrollment) process, which can be performed by either RF sequence registering or entering the detector's 11-digit serial number into the system or using RF mode panel quick key programming Sequence:

From the panel: 2) Radio Devices > 1) Allocation > 1) By RF or 2) By Code.

Enrolling using RF communication:

1. Set the receiver to Learn mode.
2. Insert the batteries (see Step 5), connect the detector to the mounting bracket and wait for at least 3 seconds. The Beyond DT will send a WRITE message. Successful learning will be indicated by:
 - (A) The system will sound a confirmation message and indicate the detector allocation in the system.
 - (B) The green LED will blink.

Enrolling through the Configuration Software:

Click Radio Device Allocation > Enter Serial Code: [11 digits]; Indexed: Automatic or manually designated 1-32; Accessory Type: 2-Way Detector (displayed). Then click Allocate: RF Allocation is performed.

For more information refer to the System Installer Manual.

Step 5: Mount the Detector on the Wall Bracket

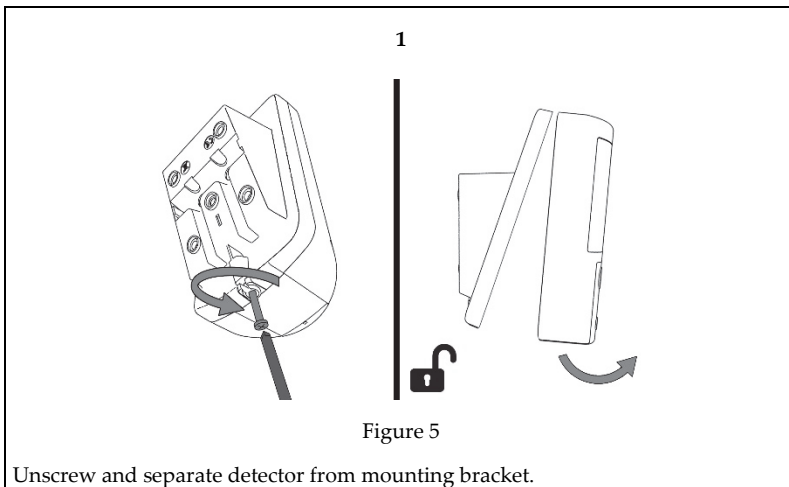

2

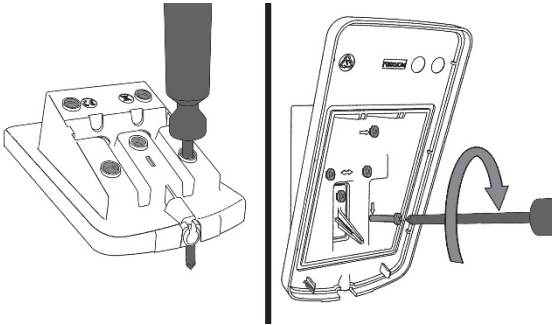

Figure 6

Open the 5 knockout holes of the wall bracket, and use as a template for mounting.

3

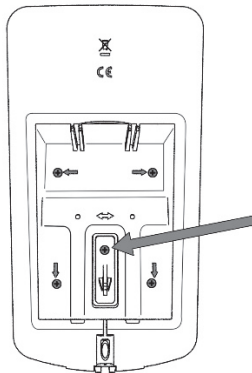

Figure 7

Secure the wall bracket to the wall using the 5 screws.

4

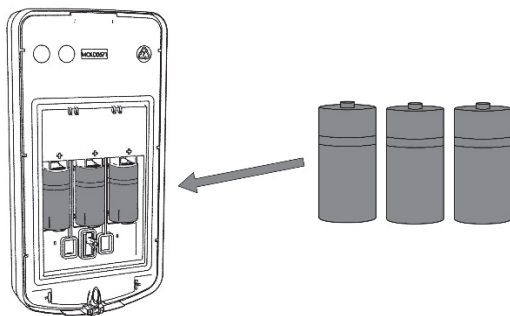

Figure 8

CAUTION! The detector batteries are supplied inside of the unit, which are covered with plastic wrapping. Remove the plastic wrapping from the batteries before installation.

Observing battery polarity, insert 3 CR123 3V Lithium batteries (supplied) into the batteries compartment.

5

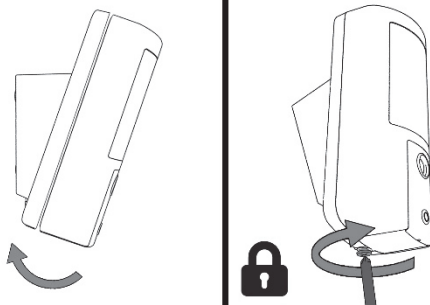
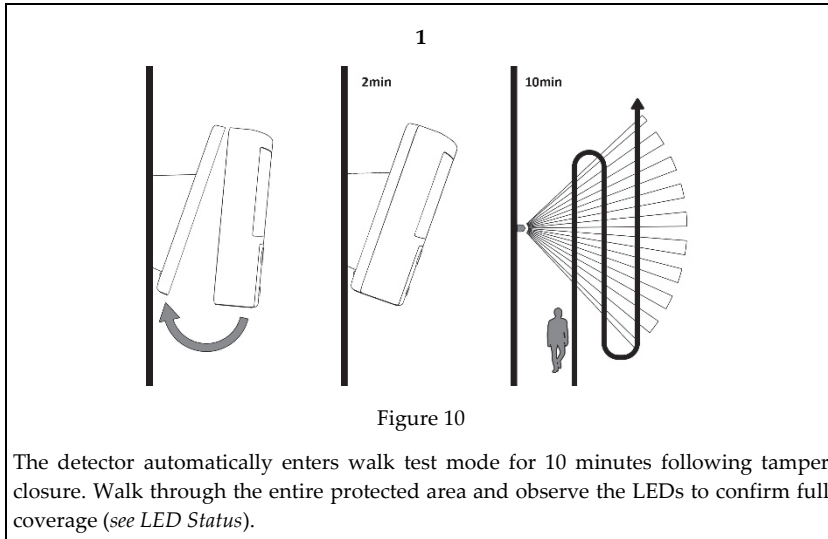

Figure 9

Insert and fasten the screw to lock the detector.

Step 6: Performing a Walk Test



2

Manually initiate a walk test:

Select User Menu: 5) Maintenance > 1) Walk Test > Select Full Walk Test or Quick Walk Test. The detector remains in walk test mode until any key on the panel is pressed.

Note: The LEDs switch off after Walk Test to avoid a situation of mapping the detection zone and to extend battery life.

Step 7: MW Range Adjustment

- 1 Over power
 - 2 Under power
 - 3 Correct adjustment
- A Detector
 - B Corridor

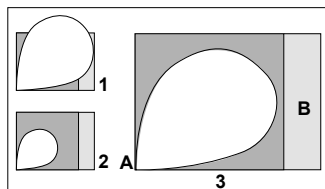

Anti-Mask Calibration

Following tamper closure, the anti-mask calibration procedure begins (up to 2 minutes). For successful calibration, make sure that there are no objects near the detector for the duration of the procedure.

Detector Configuration

Being bi-directional, the detectors parameters can be modified from the keypad or from the system configuration software according to your needs.

PIR Sensitivity:	High/Low*
MW Sensitivity	Min. 25%, 50%, 65%*, 85%, max.
Anti-Mask	Yes/No*
Supervision Time:	0-255 minutes (15 min*)
LED:	On*/Off
Operation Mode:	Walk Test: The detector transmits after each detection
	Normal*
Disposition Sensor:	Enable/Disable*
* Default	

NOTE: The Disposition Sensor sends an alarm following change in the position of the detector.

Camera Detector Configuration via RISCO Configuration Software*

Configure the camera settings through the RISCO Configuration Software (right-click on the Serial Code field in the Zones node screen and in the displayed pop-up click Additional..) or through the panel quick key programming sequence as follows (default in bold):

Programming > 2) Radio Devices > 2) Modification > 1) Zone [Select (1-32)] > 1) Parameters > 6) Advanced 5) Camera Parameters:

Images at Alarm:	3 (1 to 7 images)
Image Interval:	0.5 sec (0.5, 1, 2 seconds)
Pre-Alarm Image:	Yes (Yes, No) (Image capture upon each arm)
Image Resolution:	QVGA (QVGA 320X240 or VGA 640X480)
Image Quality:	High (High, Low)
Color Image:	Color (Color or B&W)

* Applicable to RWX350DC model

Image upon request

Snapshot images can be taken using web/smartphone apps (on panels supporting these applications).

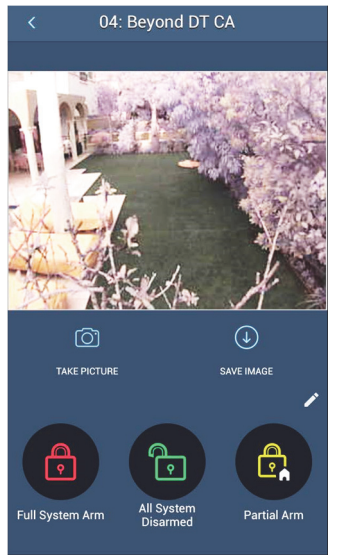

Figure 11

LED Status

LED	State	Description
Yellow	ON	PIR detection
	Flashing	Anti-Mask detection
Red	ON	Alarm, Tamper Close/Open
	Flashing (4 times)	Low battery indication
Green	ON	MW detection
	Flashing (4 times)	Successful registration

Specifications

Electrical	
Battery Type :	3 x CR 123, 3V Lithium Battery
Battery Life:	3 batteries – 3 year typical lifetime
Current consumption:	RWX350DC : 25 µA sleep; 200 mA max. peak at capture with flash RWX350D: 48 µA
Supervision Transmission:	0-255 minutes
RF transmitting frequencies:	433.92 MHz; 868.65 MHz; 869.525 MHz 916 MHz for model RWX350DC 433.92 MHz ,868.65 MHz for model RWX350D (without camera)
Optical	
Filtering:	White Light Protection
Pet Immunity:	Up to 35cm (1.1ft) animal
Physical	
Size (LxWxD):	176 x 89 x 107 mm (7 x 3.5 x 4.2 in)
Weight:	410 grams (14.5 oz.)
Environmental	
RF Immunity:	According to EN50130-4
Operating Temperature:	-30°C to 60°C (-22°F to 140°F)
Storage Temperature:	-20°C to 60°C (-4°F to 140°F)
Relative Humidity	90% max
Camera*	
Type:	CMOS digital image sensor
Lux:	0 Lux (total darkness)
View Angle:	H 90° V 71°
Power Output	Security 868.65Mhz: 10mW Camera 869.525Mhz: 100mW

RED Compliance Statement

Hereby, RISCO Group declares that this equipment is in compliance with the essential requirements and other relevant provisions of Directive 2014/53/EU. For the CE Declaration of Conformity please refer to our website: www.riscogroup.com

* Applicable to RWX350DC model

Description

Le détecteur Beyond™ DT est un détecteur DT sans fil à piles muni d'un appareil photo intégré (modèle RWX350DC) pour la vérification visuelle. Il a été conçu pour assurer une protection extérieure optimisée 24h/24, avec une fonctionnalité d'anti masque à IR actif. La double technologie (DT) intégrée associe deux canaux hyperfréquences bande K à deux capteurs IRP pour optimiser les performances de détection et l'immunité aux animaux tout en minimisant les fausses alarmes.

Principales fonctionnalités :

- Couverture IRP : 12 m, 90°
- Caméra VGA ou QVGA avec champ de vision à ~90°i
- 2 canaux Hyperfréquences bande K (**reconnaissance de mouvement de balancier**)
- Immunité aux animaux
- Deux capteurs IRP corrélés
- Capteur optique pour réduire les fausses alarmes provoquées par la lumière du soleil
- Anti masque à IR actif
- Plusieurs hauteurs de montage avec support de fixation pivotant en option
- Conçu pour une installation extérieure, résistant aux UV, indice IP 65
- Autoprotection à l'ouverture et à l'arrachement
- Accéléromètre 3 axes pour se protéger contre le vandalisme
- Support de fixation solaire pour augmenter la durée de vie de la batterie (plus de 6 ans typique) : RWX350S (en option)

Installation

Étape 1 : Considérations préliminaires

Choisissez l'emplacement de montage le mieux adapté pour couvrir la zone à protéger (*reportez-vous à l'étape 2 : diagrammes de couverture*). Respectez les consignes suivantes :

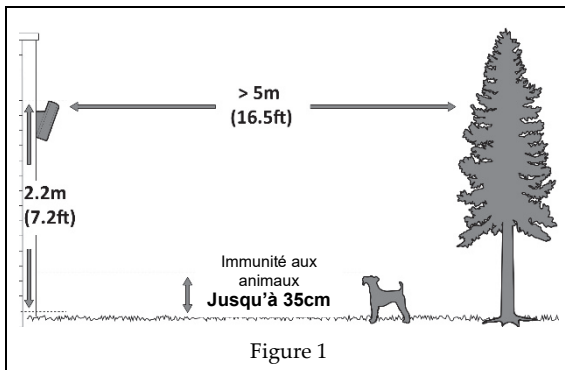

ⁱ Applicable au modèle RWX350DC

Installez l'appareil dans un lieu où aucun obstacle statique n'obstrue le champ de vision du détecteur

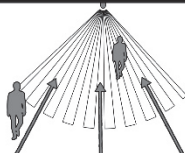
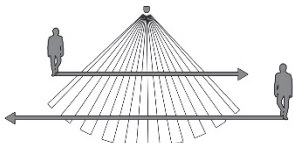

Figure 2

Veillez à ce que les personnes qui transitent dans la zone traversent les faisceaux

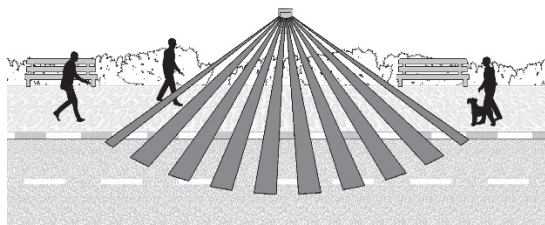

Figure 3

N'installez pas l'appareil à proximité d'objets en mouvement

Étape 2 : Diagrammes de couverture

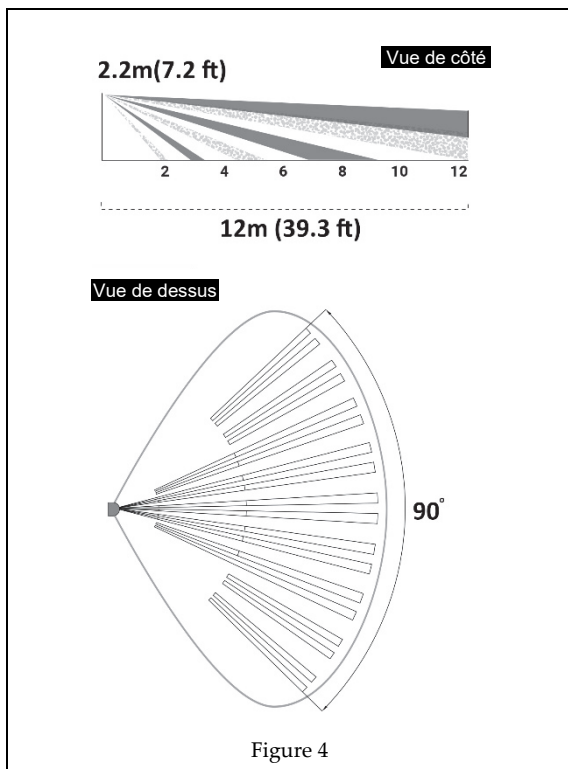

Figure 4

Étape 3 : Couverture

Couverture IRP

Hauteur d'installation [m]	Distance [m]
1,8	10
2,2 (optimale)	12

Remarque : pour l'immunité aux animaux, installez le détecteur à une hauteur optimale de 2,2 mètres

Couverture IRP – Avec rotule de fixation

Note : Le tableau suivant est applicable lorsque vous utilisez la rotule de fixation (Modèle : RA350S).

Hauteur de montage [m]	Angle de la rotule [°]	Distance [m]
1.8	0	10
	5	7
	10	5
2.2 (optimal)	0	12
	5	8
	10	6
2.5 – 2.7	0	N/A

Hauteur de montage [m]	Angle de la rotule [°]	Distance [m]
	5	10
	10	7

N/A = éviter une telle installation

Étape 4 : Enregistrement du détecteur dans le système

Le détecteur doit s'identifier au récepteur du système dans un processus d'adressage de matériel. Pour cela, vous pouvez saisir le numéro de série à 11 chiffres du détecteur dans le système ou utiliser le mode RF:

À partir de la centrale : 2) Périph. radio > 1) Adressage > 1) Adressage RF ou 2) Par N° Série.

Via la communication RF :

1. Configurez le récepteur en mode Adressage.
2. Insérez les piles (voir Étape 5), fixez le détecteur au support de montage et attendez au moins 3 secondes. Le détecteur DT Beyond envoie un message d'adressage (WRITE). Si l'adressage réussit :
 - (A) Le système émet un message sonore de confirmation pour indiquer l'adressage du détecteur dans le système.
 - (B) Le voyant vert clignote..

Enregistrement via le logiciel Configuration Software :

Cliquez sur Adressage Matériel sans fil > Saisir le numéro de série : [11 chiffres] ; Index : désigné automatiquement ou manuellement 1-32 ; Type d'accessoire : détecteur bidirectionnel (illustré).

Cliquez ensuite sur Adresser : l'adressage RF se réalise.

Consultez le guide d'installation du système pour plus d'informations.

Étape 5 : Installation du détecteur sur le support mural

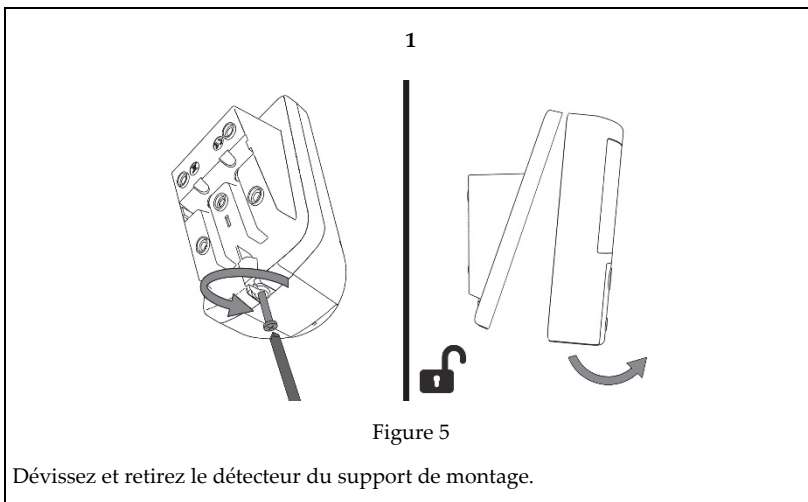

2

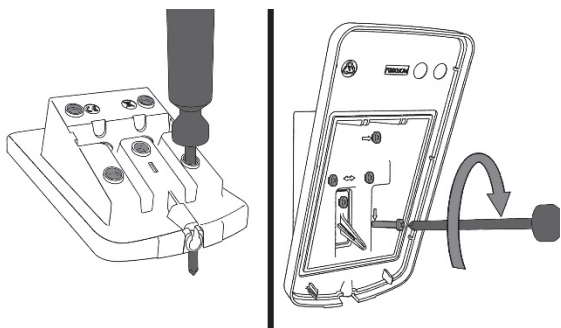

Figure 6

Ouvrez les 5 trous du support mural et utilisez-les comme gabarits pour l'installation

3

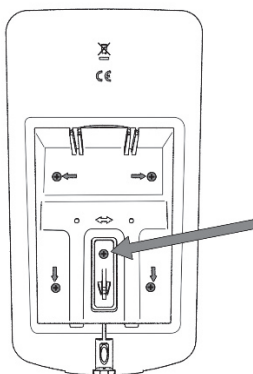

Figure 7

Fixez le support de montage au mur à l'aide des 5 vis.

4

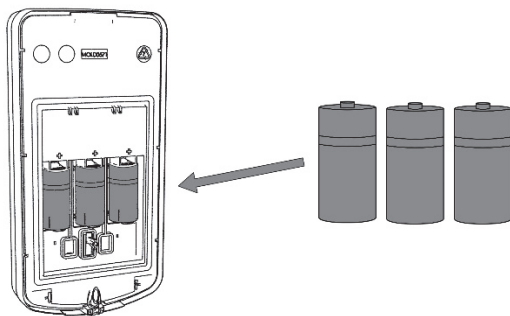

Figure 8

ATTENTION ! Les piles du détecteur sont installées dans l'unité et sont recouvertes d'une enveloppe en plastique. Retirez l'enveloppe en plastique des piles avant de procéder à l'installation.

Insérez 3 piles lithium CR123 de 3 V (fournies) dans le compartiment à piles, en respectant les polarités.

5

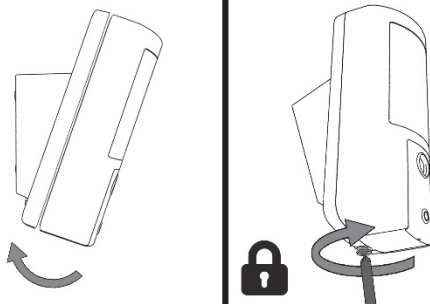
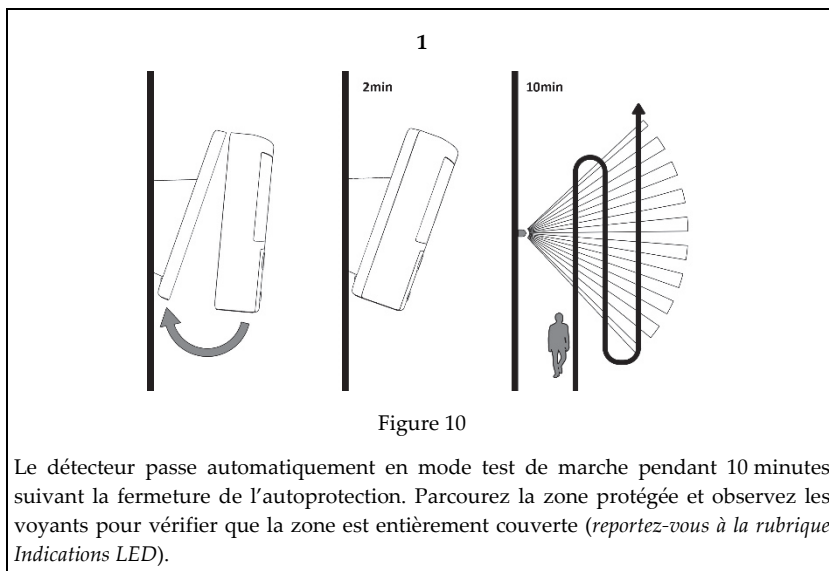

Figure 9

Insérez la vis et serrez-la pour fixer le détecteur.

Étape 6 : Test de marche



2

Test de marche manuel :

Allez dans le menu Utilisateur : 5) Maintenance > 1) Test de marche > Test de marche complet ou Test de marche rapide. Le détecteur reste en mode Test de marche jusqu'à ce que vous appuyez sur une touche.

Note : La LED s'éteint après le Test de Marche pour éviter que quelqu'un puisse repérer la zone de couverture, et pour optimiser la durée de vie des piles.

Étape 7 : Ajustement de la portée HF

1 Trop élevée

2 Trop faible

3 Ajustement correct

A Détecteur

B Couloir

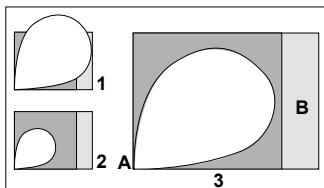

Calibrage de l'Anti-Masque

Suite à la fermeture de l'autoprotection, la procédure de calibrage de l'anti-masque démarre (2 minutes). Pour que le calibrage se réalise correctement, il faut s'assurer qu'il n'y a pas d'objet proche du détecteur pendant cette procédure.

Configuration du détecteur

Comme le détecteur est bidirectionnel, il est possible de modifier ses paramètres depuis le clavier ou le logiciel Configuration Software, selon vos besoins.

Sensibilité IRP :	Élevée/Faible*
Sensibilité Hyperfréquence :	Min., 25 %, 50 %, 65 %*, 85 % max.
Anti-Masque	Oui/Non*
Délai de supervision :	0-255 minutes (58 min*)
LED :	On*/Off
Mode de Fonctionnement :	Test de marche : le détecteur transmet après chaque détection
	Normal*
Capteur de Position :	Activé/Désactivé*
* Paramètre par défaut	

Remarque : le capteur de position envoie une alarme suite à un changement de position du détecteur.

Configuration de l'appareil photo du détecteur *

Configurez les paramètres de l'appareil photo à l'aide du logiciel Configuration Software de RISCO (cliquez avec le bouton droit de la souris sur le champ Numéro de série dans l'écran Zones, puis dans la fenêtre contextuelle qui s'affiche, cliquez sur Options) ; ou en saisissant la séquence de programmation suivante au clavier :

Menu Installateur > 1) Programmation > 2) Périph. radio > 2) Modification > 1) Zone [Sélectionner (1-32)] > 1) Paramètres > 6) Avancé > 5) Param. Photos :

Images par alarme :	3 (1 à 7 images)
Intervalle d'image :	0,5 s (0,5, 1, 2 secondes)
Image de pré-alarme :	Oui (Oui, Non) (capture d'image lors de l'armement)
Résolution :	QVGA (QVGA 320 x 240 ou VGA 640 x 480)
Qualité de l'image :	Élevée (Élevée, Faible)
Image couleur :	Couleur (Couleur ou N&B)

* Applicable au modèle RWX350DC

Images sur demande

Il est possible de prendre des captures d'image à l'aide des applications Web ou smartphone (sur les centrales prenant en charge ces applications).

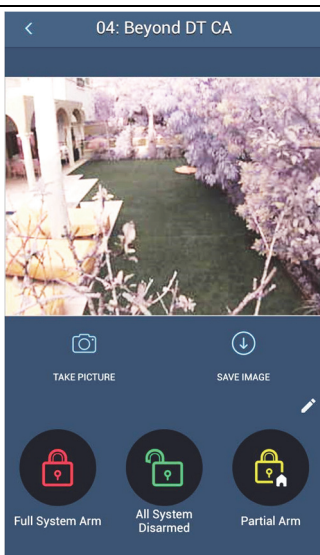

Figure 11

Indications LED

LED	État	Description
Jaune	Allumée	Détection IRP
	Clignotement	Détection anti-masque
Rouge	Allumée	Alarme, Autoprotection Ouverte / Fermée
	Clignotement (4 fois)	Indication pile basse
Vert	Allumée	Détection Hyperfréquence
	Clignotement (4 fois)	Adressage réussi

Spécifications

Électriques	
Type de pile :	3 piles lithium CR 123, 3 V
Autonomie des piles :	3 piles – autonomie standard de 3 ans
Consommation électrique :	RWX350DC : 25 µA en veille ; 200 mA max. avec utilisation du flash RWX350D : 48 µA
Transmission supervision :	0 à 255 minutes
Fréquences de transmission RF :	433,92 MHz; 868,65 MHz; 869,525 MHz 916 MHz pour le modèle RWX350DC 433,92 MHz ,868,65 MHz pour le modèle RWX350D (sans app. photo)
Optique	
Filtrage :	Protection contre les lumières blanches
Immunité aux animaux :	Jusqu'à 35 cm
Physiques	
Dimensions :	176 x 89 x 107 mm
Poids :	410 g
Environnementale	
Immunité RF :	Conforme à la norme EN50130-4
Température de fonctionnement :	-30°C à 60°C
Température de stockage :	-20°C à 60°C
Humidité relative :	90 % max.
Appareil photo*	
Type :	Capteur d'image numérique CMOS
Lux :	0 lux (obscurité totale)
Angle de vue :	H 90° V 71°
Puissance de sortie	Sécurité 868,65 Mhz : 10 mW Appareil photo 869,525 Mhz : 100 mW

Rapport de Conformité de RED

Par la présente, RISCO Group, déclare que cet équipement est en conformité aux conditions essentielles et à d'autres dispositions appropriées de la directive 2014/53/EU. Vous pouvez trouver la copie complète de la déclaration de conformité à la directive 2014/53/EU sur notre site web, à l'adresse suivante : www.riscogroup.com

Descripción

El sistema Beyond™ DT es un detector inalámbrico DT alimentado con pilas que incluye una cámara integrada (modelo RWX350DC) para verificación visual. Ha sido diseñado para ofrecer protección mejorada en exteriores 24 horas y también tiene funciones de antienmascaramiento IR activo. La tecnología dual integrada (DT) combina dos canales de microondas de banda K con dos sensores PIR para un mejor rendimiento de detección e inmunidad anti mascotas, reduciendo así al mínimo las alarmas falsas.

Funciones

- Cobertura PIR: 12 m, 90°
- Resolución de cámara VGA o QVGA con campo de visión de ~90°ⁱⁱ
- Banda K de dos canales - Detección MW (**Reconocimiento de balanceo**)
- Inmunidad a mascotas
- Dos sensores PIR correlacionados
- Sensor de luz para reducir las falsas alarmas por luz solar
- Antienmascaramiento por IR activo
- Varias alturas de montaje con rótula opcional
- Diseñado para instalación en exterior, resistente a rayos UV, IP 65
- Tamper de cubierta y de pared
- Acelerómetro de 3 ejes para protección contra actos vandálicos
- Rótula solar para mayor duración de las pilas (normalmente, 6+ años): RWX350S (opcional)

Instalación

Paso 1: Consideraciones previas

Seleccionar la ubicación de montaje que cubra mejor la zona que se va a proteger (*consultar Paso 2: Patrones de cobertura*). Respetar lo siguiente:

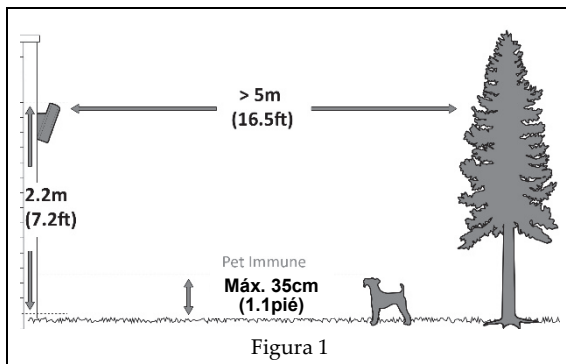

ⁱⁱ Se aplica al modelo RWX350DC

Instalar el dispositivo en un lugar donde el campo de visión del detector no tenga ningún obstáculo estático



Figura 2

La dirección de paso debe cortar el patrón del haz

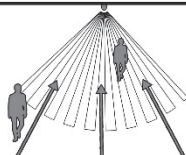
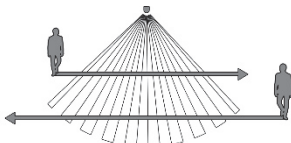

Figura 3

No instalar el dispositivo cerca de objetos en movimiento

Paso 2: Patrones de cobertura

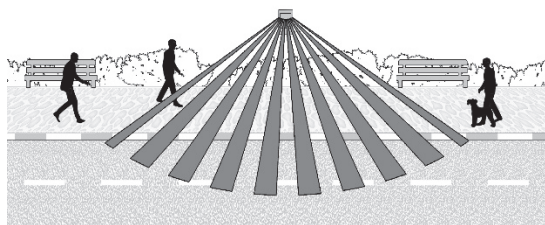
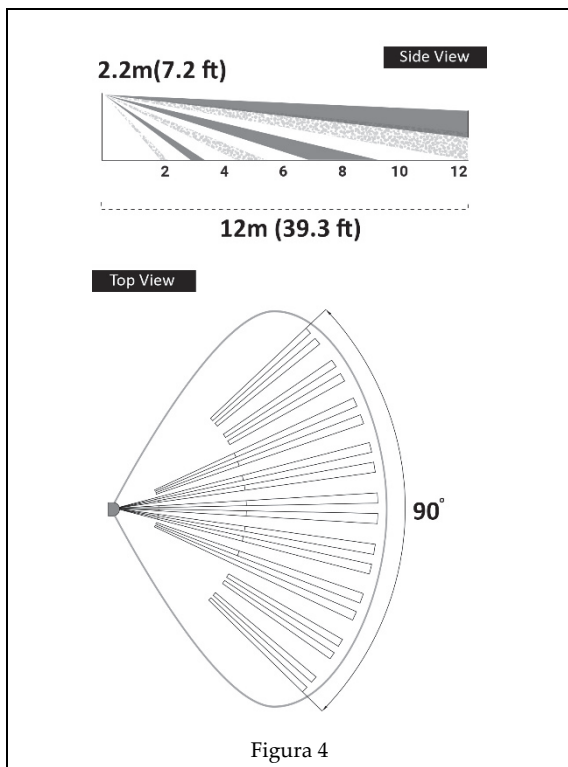

Step 3: Cobertura

Cobertura de PIR

Altura de montaje [m]	Distancia [m]
1,8	10
2,2 (óptima)	12

Nota: Para inmunidad a mascotas, instalar el detector a una altura óptima de 2,2 metros.

Cobertura de PIR – Utilizando Rótula

Nota : La siguiente tabla únicamente es relevante cuando se utiliza un Brazo de soporte con rótula o Brazo Solar (Modelo: RA350S).

Altura de montaje [m]	Ángulo de giro [°]	Distancia [m]
1,8	0	10
	5	7
	10	5
2,2 (óptima)	0	12
	5	8
	10	6
2,5	0	N/A

Altura de montaje [m]	Ángulo de giro [°]	Distancia [m]
	5	10
	10	7
2,7	0	N/A
	5	10
	10	7

NA = Evitar esta instalación

Paso 4: Registrar el detector en el sistema

El detector debe identificarse con el receptor del sistema en un proceso de asignación de dispositivos (inscripción) que puede realizarse registrando la secuencia de RF, introduciendo en el sistema el número de serie de 11 dígitos del detector o usando la secuencia de programación de teclas rápidas del panel de modo RF.

Desde el panel: 2) Disps. Radio > 1) Asignación > 1) Por RF o 2) Por código.

Inscripción mediante comunicación RF:

1. Ajustar el receptor en modo “Aprendizaje”.
2. Insertar las pilas (consultar el paso 5), conectar el detector al soporte de montaje y esperar al menos 3 segundos. El sistema Beyond DT enviará un mensaje de ESCRITURA. Si el aprendizaje se ha completado correctamente:
 - (A) El sistema emitirá un mensaje de confirmación e indicará la asignación del detector en el sistema.
 - (B) El LED rojo parpadeará.

En Inscripción mediante el Software de Configuración:

Pulsar Asignación de dispositivos de radio > Introducir Número de serie: [11 dígitos]; Indexado: 1-32 designación manual o automática; Tipo de accesorio: detector bidireccional (se muestra). Luego, pulsar Asigna.: Se lleva a cabo la asignación de RF.

Para más información, consulte el manual del instalador del sistema.

Paso 5: Montar el detector en el soporte de pared

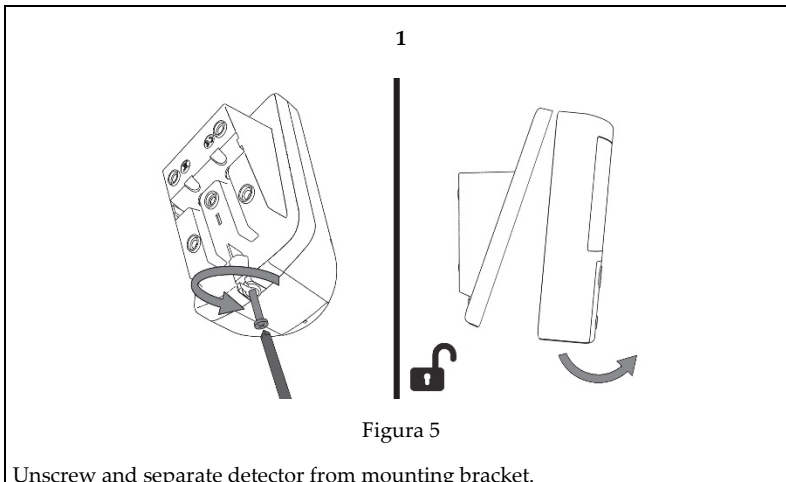

2



Figura 6

Abrir los 5 orificios troquelados del soporte de pared y usarlos como plantilla para el montaje.

3

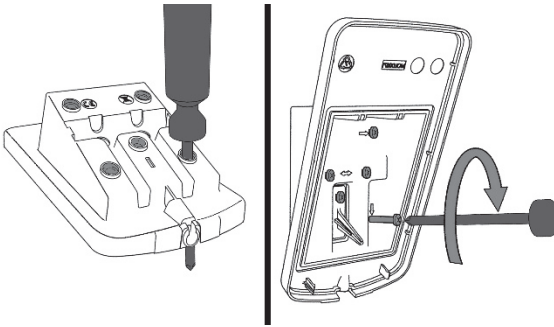

Figura 7

Fijar el soporte de montaje a la pared mediante 5 tornillos.

4

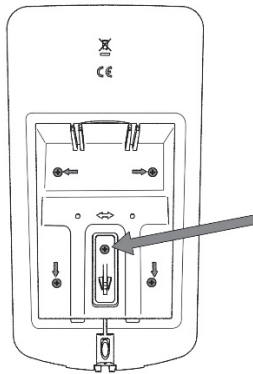

Figura 8

¡PRECAUCIÓN! Las pilas del detector se suministran dentro de la unidad y están cubiertas con una envoltura de plástico. Retirar la envoltura de plástico de las pilas antes de la instalación.

Respetando la polaridad, insertar 3 pilas CR1233 de litio de 3 V (suministradas) en el compartimento de las pilas.

5

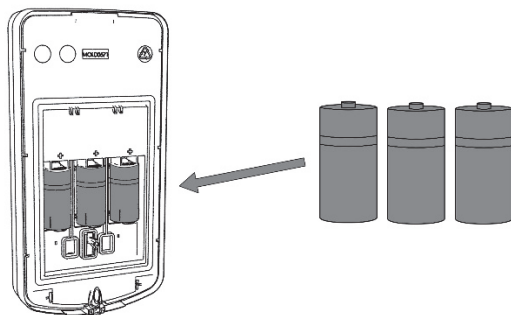

Figura 9

Introducir y fijar el tornillo para bloquear el detector.

Paso 6: Llevar a cabo un test de movimiento

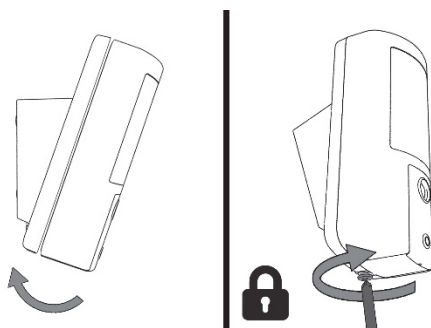
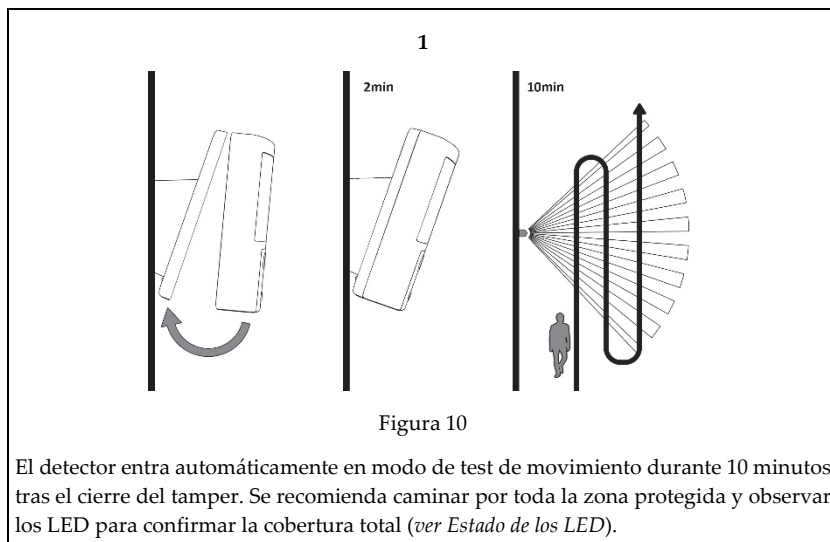

2

Iniciar manualmente un test de movimiento:

Seleccionar el menú del usuario: 5) Mantenimiento > 1) Test Movimiento > Seleccionar Test Movimiento completo o Test Movimiento rápido. El detector permanece en modo de test de movimiento mientras no se pulse ningún botón del panel

Nota: Los LED se apagan después de la prueba de paseo para evitar que pueda rastrearse la zona de detección y para aumentar la duración de la batería.

Paso 7: Rango de ajuste del MW

- 1 Exceso de potencia A Detector
- 2 Falta de potencia B Corredor
- 3 Ajuste correcto

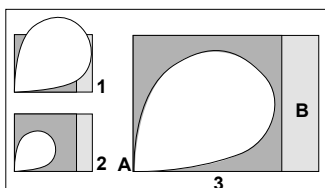

Calibración de Anti-enmascaramiento

Después de cerrar el tamper se inicia el procedimiento de calibración del anti-enmascaramiento (hasta 2 minutos). Para que la calibración pueda finalizar correctamente, compruebe que no hay objetos cerca del detector durante todo el proceso.

Configuración de los detectores

Al ser un sistema bidireccional, los parámetros de los detectores se pueden modificar desde el teclado o desde el software de configuración del sistema según sus necesidades.

Sensibilidad PIR:	Alta/Baja*
Sensibilidad MW:	Mín. 25%, 50%, 65%*, 85%, máx.
Anti-Mask	Sí/No*
Tiempo de supervisión:	0-255 minutos (15 min*)
LED:	Encendido*/Apagado
Modo de funcionamiento:	Test de movimiento: El detector transmite tras cada detección Normal*
Sensor de disposición:	Activado/Desactivado*
* Por defecto.	

Nota: El sensor de disposición envía una alarma tras un cambio en la posición del detector.

Configuración de los detectores de la cámara mediante el Software de Configuración de RISCO*

Es posible configurar los ajustes de la cámara mediante el software de configuración de RISCO (pulsar con el botón derecho en el campo Número de serie en la pantalla de zonas y, en el mensaje que aparece, pulsar Adicional) o bien mediante una secuencia de programación de teclas rápidas del panel, tal y como se puede ver a continuación (en negrita los valores por defecto):

Programación > 2) Disps. Radio > 2) Modificación > 1) Zona [Seleccionar (1-32)] > 1) Parám. > 6) Parám. Avanz.: 5) Parám. Cámara:

Imágenes de alarma:	3 (1 - 7 imágenes)
Intervalo de imagen:	0,5 s (0,5, 1, 2 segundos)
Imagen de prealarma:	Sí (Sí, No) (Captura de imagen en cada armado)
Resolución de imágenes:	QVGA (QVGA 320X240 o VGA 640X480)
Calidad de imagen:	Alta (Alta, Baja)
Color de imagen:	Color (Color o B/N)

* Se aplica al modelo RWX350DC

Imágenes bajo demanda

Se pueden tomar instantáneas con aplicaciones web/smartphone (en paneles que admitan estas aplicaciones).



Figura 11

Estado de los LED:

LED	State	Description
Amarillo	Encendido	Detección PIR
	Parpadeo	Detección de antiennascaramiento
Rojo	Encendido	Alarma, Cierre/Apertura Tamper
	Parpadeo (4 veces)	Indicación de pila baja
Verde	Encendido	Detección MW
	Parpadeo (4 veces)	Successful registration

Especificaciones

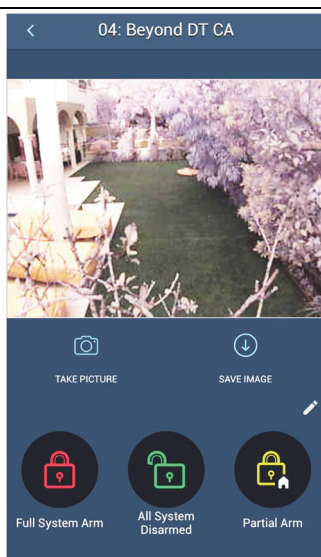
Datos eléctricos	
Tipo de pila:	Pila CR123 de litio de 3 V (x3)
Duración de la pila:	3 pilas – normalmente 3 años
Consumo de corriente:	RWX350DC: 25 μ A en reposo; 200 mA pico máx. en captura con flash RWX350D: 48 μ A
Transmisión de supervisión:	0-255 minutos
Frecuencias de transmisión de RF:	433,92 MHz; 868,65 MHz; 869,525 MHz 916 MHz para el modelo RWX350DC 433,92 MHz ,868,65 MHz para el modelo RWX350D (sin cámara)
Óptica	
Filtrado:	Protección de luz blanca

Inmunidad a mascotas:	Animales de hasta 35cm de altura
Datos físicos	
Tamaño:	176 x 89 x 107 mm
Peso:	410 gramos
Environmental	
Inmunidad RF:	Según la norma EN50130-4
Temperatura de funcionamiento:	De -30 °C a 60 °C
Temperatura de almacenamiento:	De -20 °C a 60 °C
Humedad relativa	90% max
Cámara *	
Tipo:	Sensor de imagen digital CMOS
Lux:	0 Lux (oscuridad total)
Ángulo de visión:	H 90° V 71°
Potencia de salida	Seguridad 868,65 MHz: 10 mW Cámara 869,525 MHz: 100 mW

Declaración de Conformidad RED :

Por la presente, RISCO Group declara que este equipo cumple con los requisitos esenciales y otras disposiciones relevantes de la Directiva 2014/53/EU. Para la Declaración de Conformidad CE, por favor diríjase a nuestra web: www.riscogroup.com

* Se aplica al modelo RWX350DC

Descrizione

Il modello Beyond™ DT è un rivelatore radio doppia tecnologia che supporta la Video Verifica grazie alla fotocamera integrata (modello RWX350DC) e garantisce una protezione da esterno 24h, con tecnologia Anti-Mascheramento a IR attivi.

Beyond DT combina due canali Microonda in banda K con due canali PIR per garantire una rilevazione efficace, discriminazione animali e ridurre drasticamente i falsi allarmi.

NOTA: Il rivelatore è supportato delle seguenti centrali con le relative versioni firmware: Agility 5.10 (modello RWX350DC e RWX350D), LightSYS 5.73 (modello RWX350D), ProSYS Plus 1.2.0 (modello RWX350DC).

Le caratteristiche includono:

- Copertura PIR: 12m, 90°
- Risoluzione fotocamera VGA o QVGA con angolo di visuale ~90°
- Due canali MW in banda K (**Sway Recognition Technology**)
- Discriminazione Animali
- Due sensori PIR correlati (**Digital Correlation Technology**)
- Gestione della luce solare diretta per ridurre i falsi allarmi
- Anti mascheramento con IR attivo
- Diverse altezze di installazione con lo snodo opzionale
- Progettato per installazione in esterno, resistente ai raggi UV, IP 65
- Tamper anti-apertura e anti-rimozione
- Accelerometro a 3 assi per protezione contro gli atti vandalici
- Snodo opzionale con Pannello Solare, per aumentare la durata delle batterie (> 6 anni con un utilizzo normale) RWX350S

Installazione

Passo 1: Considerazioni Preliminari

Selezionare la posizione di installazione per ottenere la migliore copertura dell'area da proteggere (vedi *Passo 2: Diagrammi di Copertura*). Fare riferimento alle indicazioni seguenti:



Figura 1

Selezionare una posizione di installazione dove l'area protetta sia libera da ostacoli

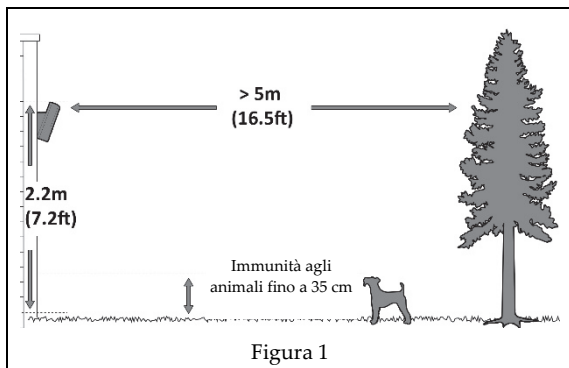

Figura 2

L'intruso deve attraversare i fasci di rilevazione

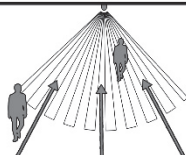
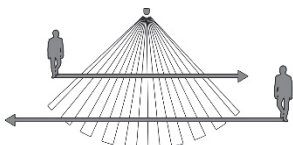

Figura 3

Scegliere una posizione di installazione dove non ci sia un costante e continuo movimento

Passo 2: Diagrammi di copertura

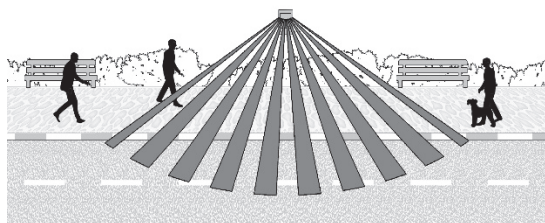

Figura 4

Passo 3: Area di copertura

Area di copertura PIR

Altezza di Installazione [m]	Copertura [m]
1.8	10
2.2 (ottimale)	12

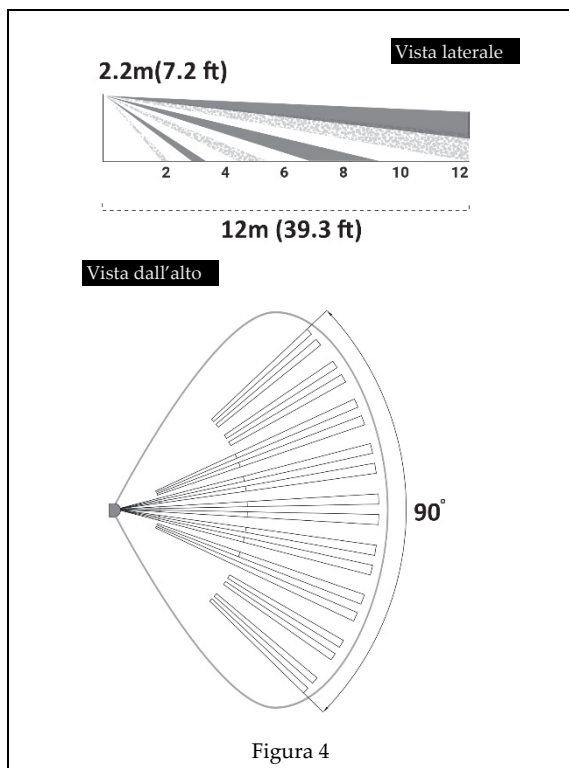
Nota: Per avere la Discriminazione Animali installare il rivelatore a 2.2m

Area di copertura PIR – Utilizzando lo snodo

Nota: la tabella che segue è valida solo quando, per l'installazione, si utilizza lo Snodo/Snodo con pannello solare (Modello: RA350S).

Altezza di Installazione in metri	Angolo di inclinazione in gradi	Distanza in metri
1.8	0	10
	5	7
	10	5
2.2 (ottimale)	0	12
	5	8
	10	6
2.5 – 2.7	0	N/A

Altezza di Installazione in metri	Angolo di inclinazione in gradi	Distanza in metri
	5	10
	10	7

NA = Evitare questa installazione

Passo 4: Memorizzazione del Dispositivo

Il rivelatore deve essere memorizzato sulla centrale e questo avviene inviando un messaggio di scrittura al ricevitore, inserendo il suo codice seriale di 11 cifre nell'apposito menu oppure attraverso la memorizzazione rapida (solo Agility).

Memorizzazione tramite Numero Seriale/Messaggio di scrittura (WRITE):

Agility: Programmazione Tecnica: 2) Access. Radio > 1) Memoriz. Radio > 1) Via Radio oppure 2) Via Nr. Serie.

LightSYS/Prosys PLUS: Programmazione Tecnica: 7) Configurazione > 2) Access. Radio > 2) Memorizza > 1) Via Radio oppure 2) Via Nr. Serie

Memorizzazione rapida (solo Agility):

1. Impostare la centrale in ascolto tenendo premuto il tasto a bordo dell'unità centrale Agility.
2. Inserire le batterie nel rivelatore (vedi Passo 5), collegare il rivelatore alla sua base di fissaggio e attendere 3 secondi. Il Beyond DT invierà un messaggio di scrittura. Il corretto apprendimento verrà indicato con:
 - (A) La centrale riprodurrà un messaggio di conferma indicando la registrazione del dispositivo.
 - (B) Il LED rosso lampeggerà.

Memorizzazione attraverso Software CS:

Selezionare Memorizzazione Periferiche Radio > Inserire il Numero Seriale [11 cifre];

Memorizzazione permette di scegliere la zona da occupare: Automatico o Manuale (zone 1-32); Tipo Periferica: mostrerà Rivelatore 2way automaticamente. Cliccare Memorizza.

Per maggiori informazioni consultare il Manuale Tecnico della centrale.

Passo 5: Montaggio del rivelatore sulla base di fissaggio

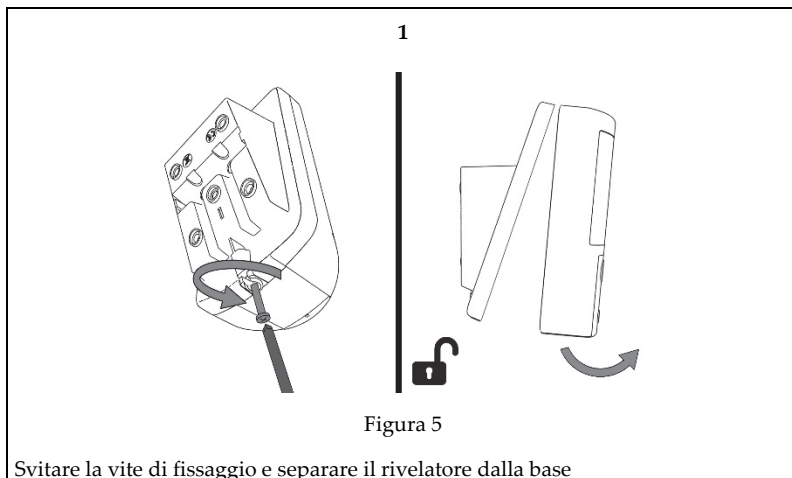

2



Figura 6

Aprire i 5 fori predisposti sulla base di fissaggio ed utilizzare la base stessa come dima per predisporre il montaggio a parete.

3

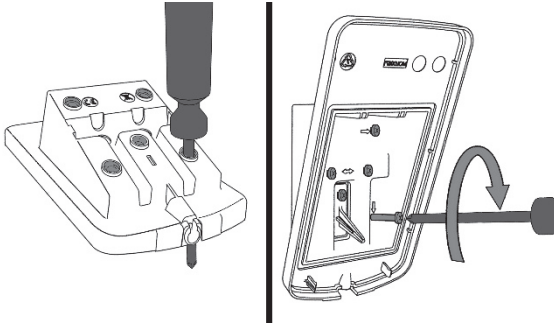

Figura 7

Fissare la base al muro con 5 viti.

4

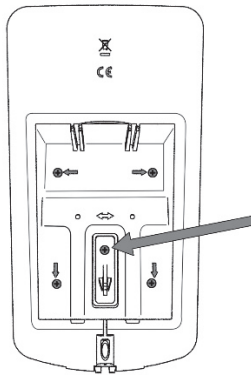

Figura 8

ATTENZIONE! Le batterie vengono fornite all'interno del rivelatore e sono alloggiare al suo interno con una protezione plastica. Rimuovere questa protezione prima dell'installazione.

Osservando la polarità, alloggiare le 3 batterie CR123 3V al Litio (fornite).

5

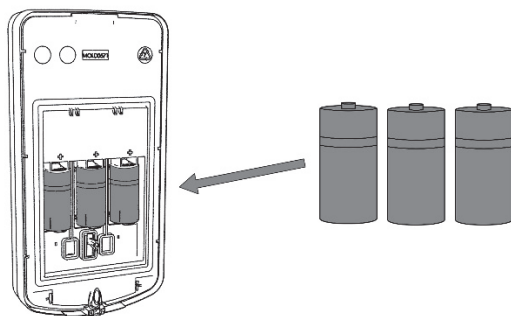

Figura 9

Inserire e avvitare la vite di blocco.

Passo 6: Prova di movimento

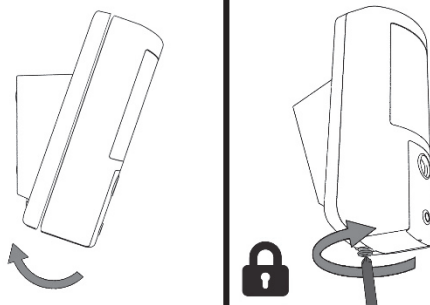
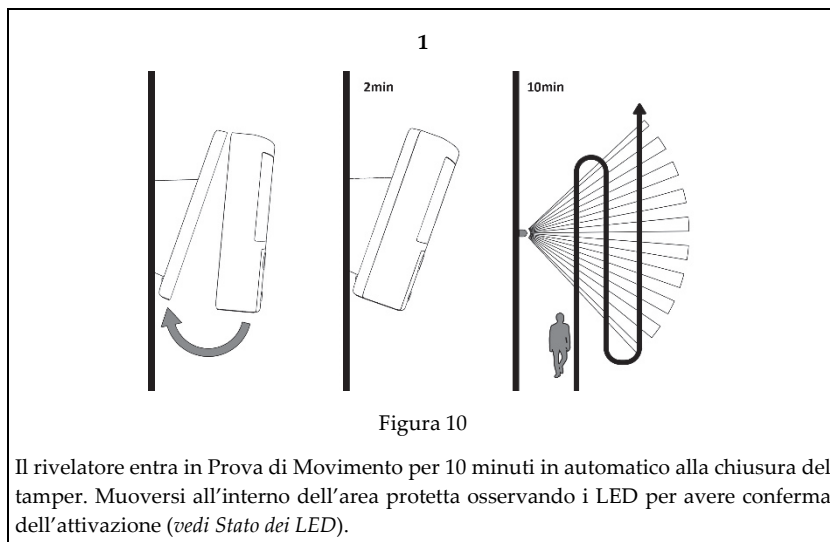

2

Attivare il Modo Test manualmente:

Agility

Menu Tecnico: Diagnostica > 2) Zone > Test Sensori.

LightSYS/ProSYS PLUS

Menu Tecnico: Manutenzione > Test Zone > Zone Attive/Zone non attive

Nota: I LED verranno spenti dopo la prova di movimento al fine di preservare il consumo delle batterie ed evitare che qualche maleintenzionato possa verificare le aree protette dal rivelatore.

Passo 7: Regolazione portata Microonda

- 1 Portata eccedente A Rivelatore
- 2 Portata insufficiente B Corridoio
- 3 Regolazione corretta

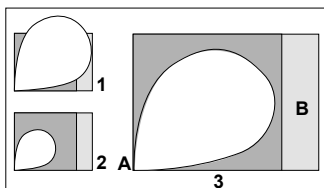

Calibrazione Antimascheramento

Alla chiusura dell'interruttore tamper del rivelatore inizia la procedura di calibrazione del circuito di Antimascheramento (durata circa 2 minuti). Affinché la calibrazione venga effettuata correttamente assicurarsi che non ci siano oggetti molto vicini al rivelatore per tutta la durata della procedura.

Parametri Rivelatore

Essendo un dispositivo bidirezionale, i parametri del Beyond™ DT possono essere modificati da tastiera o da Software CS.

Sensibilità	Alta/Bassa*
Sensibilità MW	Min. 25%, 50%, 65%*, 85%, max.
Anti-Mask	Si, No*
Tempo Supervisione	0-255 minuti (58 min.*)
LED	Acceso*/Spento
Modo Operativo	Prova Movimento: Trasmissione ad ogni rilevazione
	Normale*: Inibizione trasmissioni (2.5 min.)*
Sens. di Posizione (Accelerometro):	Abilitato/Disabilitato*
* Default	

Nota: Il sensore di posizione genera un allarme a seguito dello spostamento fisico del rivelatore.

Configurazione della Fotocamera

È possibile modificare i parametri della fotocamera integrata attraverso il Software CS (cliccando con il tasto destro del mouse sulla zona dove è memorizzato il Beyond™ DT) oppure utilizzando la tastiera dell'impianto come indicato di seguito:

Agility

Menu Tecnico > 2) Access. Radio > 2) Programma > 1) Zone [Selezionare (1-32)] > 1) Parametri > 6) Avanzate 5) Parametri TCamera:

Immagini Allarme:	3 (da 1 a 7 immagini)
Intervallo Immagini:	0.5 sec (0.5, 1, 2 secondi)
Immag. Pre Allarme:	Si (Si, No)
Risoluz. Immagine:	QVGA (QVGA 320X240 o VGA 640X480)
Qualità Immagine:	Alta (Alta, Bassa)
Colore Immagine.:	Colore (Colore o B&W)

Scatti su richiesta (scatti immagine)

È possibile effettuare scatti su richiesta in qualsiasi momento utilizzando l'App per smartphone iRISCO o dal sito web www.riscocloud.com, usando le proprie credenziali.

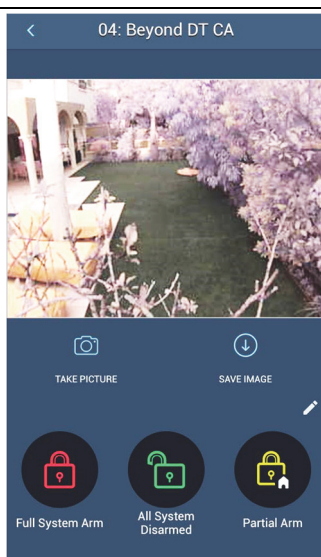

Figure 11

Stato dei LED

LED	Stato	Descrizione
Giallo	Acceso	Rilevazione PIR
	Lampeggiante	Rilevazione Mascheramento
Rosso	Acceso	Allarme, Tamper Aperto/Chiuso
	4 lampeggi	Basso livello batterie
Verde	Acceso	Rilevazione MW

Specifiche Tecniche

Elettriche	
Tipo batteria	3 x CR 123, 3V al Litio
Durata batterie	3 batterie – 3 anni (durata tipica)
Assorbimento	RWX350DC: 25 μ A in modalità “sleep”; 200 mA. max. di picco con scatto con flash. RWX350D: 48 μ A
Trasmissione Supervisione	0-255 minuti
Frequenze RF operative	433.92 MHz; 868.65 MHz; 869.525 MHz 916 MHz modello RWX350DC 433.92 MHz ,868.65 MHz modello RWX350D (senza fotocamera)
Ottiche	
Filtri	Protezione Luci Bianche
Immunità agli animali	Fino a 35 cm
Fisiche	
Dimensioni	176 x 89 x 107 mm
Peso	410 grammi
Ambientali	
Immunità RF	Conforme EN50130-4
Temp. di funzionamento	Da -30°C a 60°C
Temp. di stoccaggio	Da -20°C a 60°C
Umidità relativa	90% max.
Fotocamera*	
Tipo	CMOS sensore digitale
Lux	0 Lux (oscurità totale)
Angolo di visuale	H 90° V 71°
Emissioni	Rilevazione 868.65Mhz: 10mW Fotocamera 869.525Mhz: 100mW

Dichiarazione di conformità RED:

La sottoscritta RISCO Group, dichiara sotto la propria responsabilità che questo prodotto è conforme ai requisiti essenziali e alle altre rilevanti disposizioni della Direttiva Europea 2014/53/EU. Per le Dichiarazioni di Conformità CE, visitate il nostro sito: www.riscogroup.com

* Applicabile solo al modello RWX350DC

Descrição

O Beyond™ DT é um detector de dupla tecnologia (DT) sem fio que funciona a bateria e conta com uma câmera integrada (no modelo RWX350DC) para verificação visual. Ele foi projetado para oferecer uma proteção externa aprimorada 24 horas, com recursos antimascaramento por infravermelho ativo. A dupla tecnologia (DT) integrada combina dois canais de micro-ondas de banda K com dois sensores PIR para obter um melhor desempenho de captura e imunidade a animais de estimação, minimizando alarmes falsos.

Características

- Cobertura PIR: 12 m, 90°
- Resolução de câmera VGA ou QVGA com campo de visão de até 90°
- Dois canais de banda K - Detecção por micro-ondas (**reconhecimento de oscilação**)
- Imunidade a animais de estimação
- Dois sensores PIR correlacionados
- Sensor de luz para reduzir alarmes falsos devido à luz solar
- Antimascaramento por infravermelho ativo
- Várias alturas de montagem com suporte giratório opcional
- Projetado para instalação externa, resistente a raios UV, IP 65
- Protetores antivolação de tampa e parede
- Acelerômetro triaxial para proteção contra vandalismo.
- Suporte giratório solar para maior duração da bateria (normalmente mais de 6 anos): RWX350S (opcional)

Instalação

Passo 1: Considerações iniciais

Selecione o local de montagem para obter a maior cobertura da área a ser protegida (*ver Passo 2: Padrões de cobertura*). Observe as recomendações a seguir:

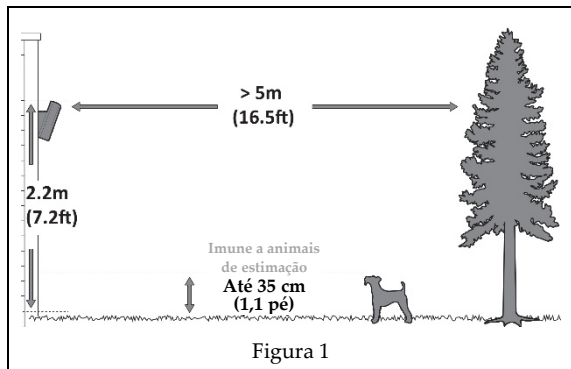

* Aplicável ao modelo RWX350DC

Instale o dispositivo em um local onde o campo de visão do detector não tenha obstruções estáticas.



Figura 2

A direção da caminhada deve cruzar o padrão do feixe

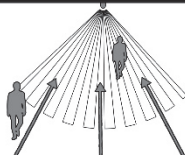
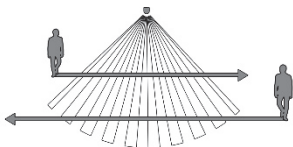

Figura 3

Não instale o dispositivo perto de objetos em movimento

Passo 2: Padrões de cobertura

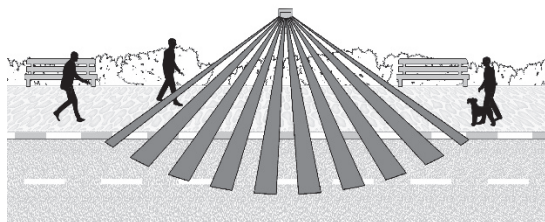
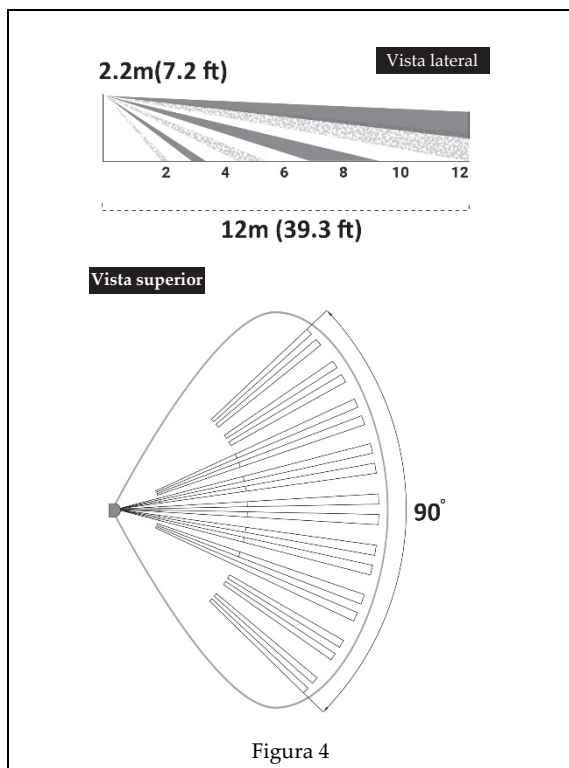

Passo 3: Cobertura

Cobertura PIR

Altura de instalação [m]	Distância [m]
1,8	10
2,2 (ideal)	12

Nota: Para obter imunidade a animais de estimação, instale o detector a uma altura ideal de 2,2 metros.

Cobertura PIR – Com suporte Giratório

Nota: A tabela abaixo é relevante quando se utiliza o Suporte Giratório / Solar (Model: RA350S).

Altura da Instalação [m]	Ângulo do Suporte Giratório [°]	Distância [m]
1,8	0	10
	5	7
	10	5
2,2 (ideal)	0	12
	5	8
	10	6

Altura da Instalação [m]	Ângulo do Suporte Giratório [°]	Distância [m]
2,5	0	–
	5	10
	10	7
2,7	0	–
	5	10
	10	7

NA = Evite tal instalação

Passo 4: Registro do detector no sistema

O detector deve ser identificado pelo receptor do sistema em um processo de atribuição (cadastro) de dispositivos. O processo pode ser realizado por meio do registro de uma sequência de RF ou da inserção do número de série (de 11 dígitos) do detector no sistema, ou ainda usando a sequência de programação por teclas rápidas do painel no modo RF:

Pelo painel: 2) Radio Devices (Dispositivos de rádio) > 1) Allocation (Atribuição) > 1) By RF (Por RF) ou 2) By Code (Por código).

Cadastro usando a comunicação por RF:

1. Coloque o receptor no modo Learn (Memorizar).
2. Insira as baterias (ver Passo 5), conecte o detector no suporte de montagem e aguarde pelo menos 3 segundos. O Beyond DT enviará uma mensagem de "WRITE" (Gravação). Para indicar que a memorização foi bem-sucedida:
 - (A) O sistema emitirá o som de uma mensagem de confirmação e indicará a atribuição do detector no sistema.
 - (B) O LED verde irá piscar.

Cadastro com o software de configuração:

Clique em Radio Device Allocation (Atribuição de dispositivo de rádio) > Insira o número de série: [11 dígitos]; Indexed (Indexado): Automatic (Automático) ou designado de forma manual de 1 a 32; Accessory Type (Tipo de acessório): 2-Way Detector (Detector bidirecional) (exibido). Em seguida, clique em Allocate (Atribuir): A atribuição de RF será realizada.

Para saber mais, consulte o Manual do Instalador do Sistema

Passo 5: Montagem do detector no suporte de parede

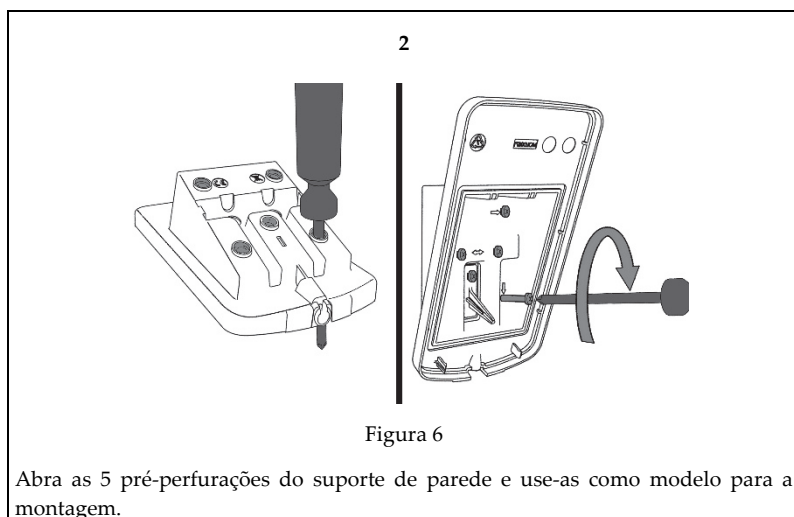
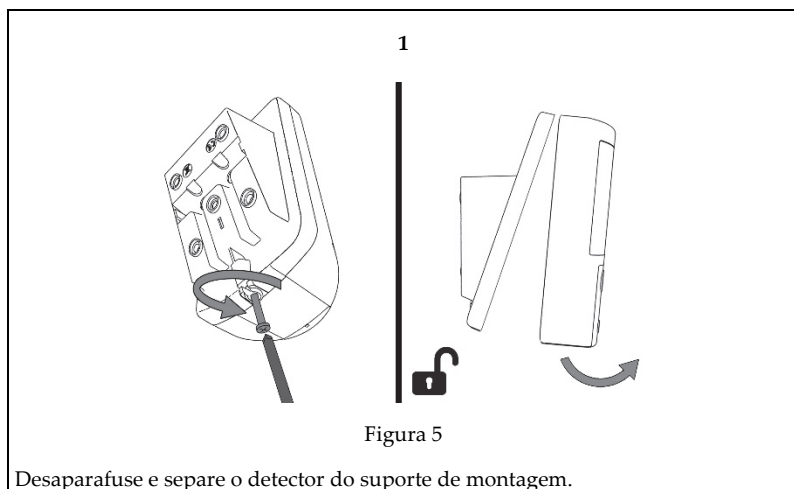

3



Figura 7

Prenda o suporte à parede usando os 5 parafusos.

4

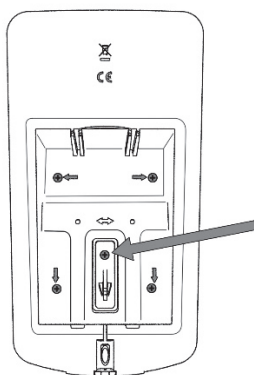

Figura 8

CUIDADO: As baterias do detector são fornecidas dentro da unidade e são cobertas por um plástico. Remova o plástico das baterias antes da instalação.

Observando a polaridade correta, insira 3 baterias de lítio CR123 de 3 V (fornecidas) no respectivo compartimento.

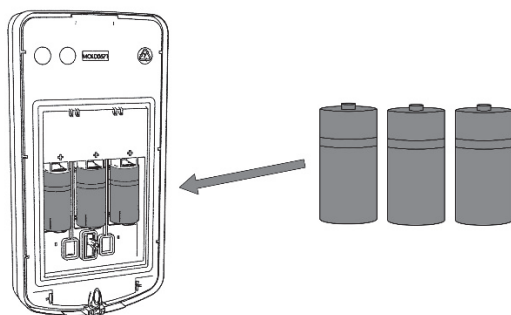
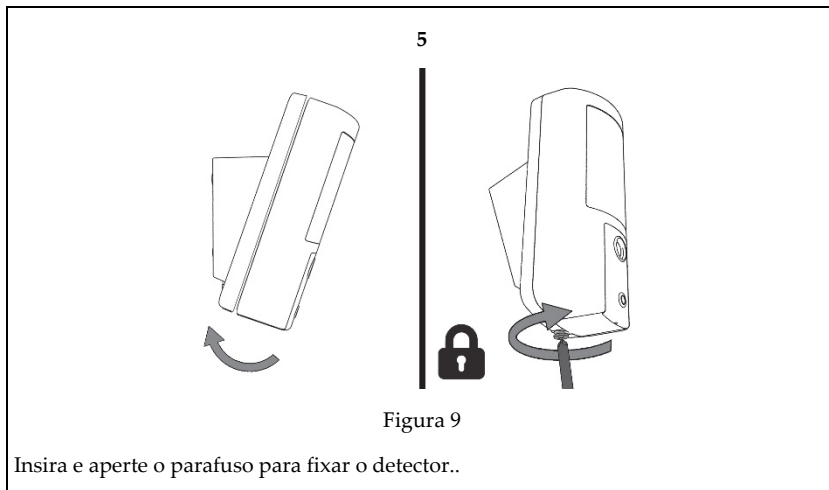

Passo 6: Execução de um teste de caminhada

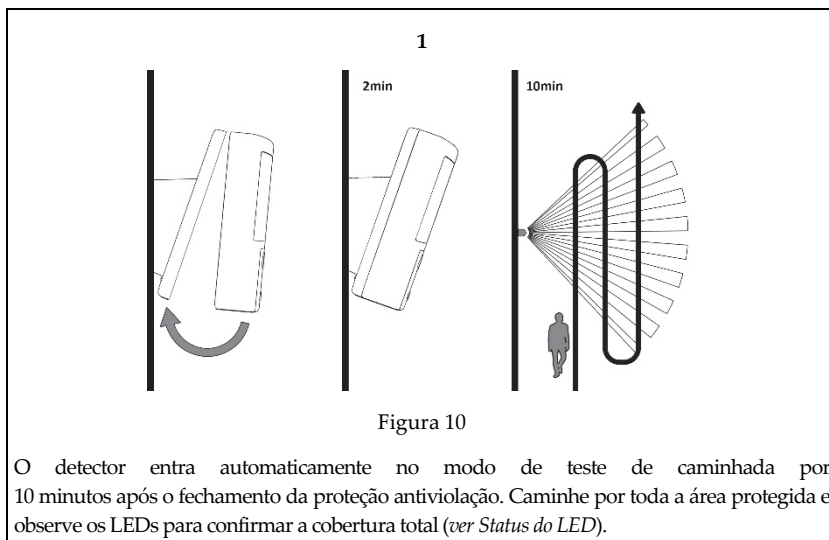

Inicie manualmente um teste de caminhada:

Selecione User Menu (Menu do usuário): 5) Maintenance (Manutenção) > 1) Walk Test (Teste de caminhada) > Selecione a opção Full Walk Test (Teste de caminhada completo) ou Quick Walk Test (Teste de caminhada rápido). O detector permanece no modo de teste de caminhada até que alguma tecla no painel seja pressionada.

Nota: Os LEDs são desligados após o teste de caminhada para evitar uma situação de mapeamento da zona de detecção e prolongar a duração da bateria.

Passo 7: Ajuste do alcance de micro-ondas

- 1 Potência excessiva A Detector
- 2 Potência insuficiente B Corredor
- 3 Ajuste correto

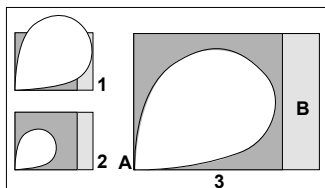
**Calibração antimascaramento**

Após o fechamento da proteção antivolação, o procedimento de calibração antimascaramento é iniciado (até 2 minutos). Para que a calibração seja bem-sucedida, não deve haver objetos próximos ao detector durante o procedimento.

Configuração do detector

Como os detectores são bidirecionais, seus parâmetros podem ser modificados pelo teclado ou pelo software de configuração do sistema de acordo com as suas necessidades.

Sensibilidade do PIR:	Alta/baixa*
Sensibilidade de micro-ondas	Mín. 25%, 50%, 65%*, 85%, máx.
Antimascaramento	Sim/não*
Tempo de supervisão:	0-255 minutos (15 min*)
LED:	Ligado*/desligado
Modo de operação:	Teste de caminhada: o detector transmite após cada detecção Normal*
Sensor de disposição:	Ativar/desativar*
* Padrão	

Nota: O sensor de disposição envia um alarme após a mudança da posição do detector.

Configuração do detector da câmera pelo software de configuração da RISCO*

Para alterar as configurações da câmera pelo software de configuração da RISCO, clique com o botão direito no campo Serial Code (Número de série) na tela dos nós das zonas. Em seguida, clique em Additional (Adicional) na janela pop-up exibida. As configurações também podem ser alteradas pela sequência de programação por teclas rápidas do painel, da seguinte forma (padrão em negrito):

Programming (Programação) > 2) Radio Devices (Dispositivos de rádio) > 2) Modification (Modificação) > 1) Zone (Zona) [Selecionar (1–32)] > 1) Parameters (Parâmetros) > 6) Advanced (Avançado) > 5) Camera Parameters (Parâmetros da câmera):

Imagens em alarme:	3 (1 a 7 imagens)
Intervalo de imagens:	0,5 s (0,5, 1, 2 segundos)
Imagem pré-alarme:	Sim (sim, não) (captura de imagem em cada armação)
Resolução da imagem:	QVGA (QVGA 320 X 240 ou VGA 640 X 480)
Qualidade da imagem:	Alta (alta, baixa)
Cor da imagem:	Colorida (colorida ou P&B)

Imagem sob solicitação

Imagens instantâneas podem ser tiradas usando apps para Web/smartphone (em painéis compatíveis com esses aplicativos).

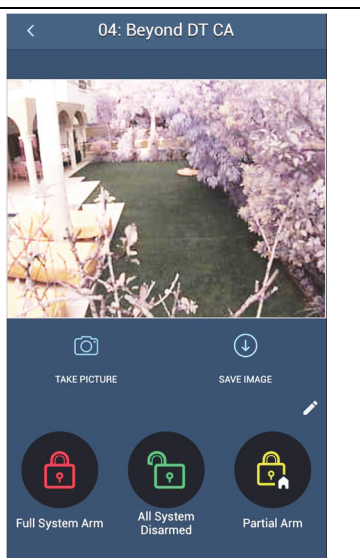

Figure 11

* Aplicável ao modelo RWX350DC

Status do LED

LED	State	Descrição
Amarelo	Ligado	Detecção PIR
	Piscando rápido	Detecção antimascaramento
Vermelho	Ligado	Alarme, violação fechada/aberta
	Piscando (4 vezes)	Indicação de bateria fraca
Verde	Ligado	Detecção por micro-ondas
	Piscando (4 vezes)	Registro bem-sucedido

Especificações

Elétricas	
Tipo de bateria:	3 x baterias de lítio CR 123 de 3V
Duração das baterias:	3 baterias – Duração normal de 3 anos
Consumo de corrente:	RWX350DC: 25 μ A em suspensão; 200 mA em pico máx. de captura com flash RWX350D: 48 μ A
Transmissão de supervisão:	0-255 minutos
Frequências de transmissão de RF:	433,92 MHz; 868,65 MHz; 869,525 MHz 916 MHz para o modelo RWX350DC 433,92 MHz, 868,65 MHz para o modelo RWX350D (sem câmera)
Optical	
Filtragem:	Proteção contra luz branca
Imunidade a animais de estimação:	Até 35 cm
Físicas	
Tamanho:	176 x 89 x 107 mm (7 x 3,5 x 4,2 pol.)
Peso:	410 g (14,5 oz)
Ambientais	
Imunidade a RF:	Em conformidade com a EN50130-4
Temperatura de funcionamento:	-30 °C a 60 °C (-22 °F a 140 °F)
Temperatura de armazenamento:	-20 °C a 60 °C (-4 °F a 140 °F)
Umidade relativa	Máx. de 90%
Câmera*	
Tipo:	Sensor de imagem digital CMOS
Lux:	0 lux (escuridão total)
Ângulo de visão:	H: 90° V: 71°

* Aplicável ao modelo RWX350DC

Potência de saída	Segurança - 868,65 MHz: 10 mW Câmera - 869,525 MHz: 100 mW
-------------------	---

Declaração de conformidade RED

Por meio deste, a RISCO Group declara que seu equipamento está em conformidade com as necessidades essenciais e outras provisões relevantes da diretiva 2014/53/EU. | Para ver a declaração de conformidade da CE, por favor consulte a nossa website: www.riscogroup.com

Standard Limited Product Warranty (“Limited Warranty”)

RISCO Ltd. (“RISCO”) guarantee RISCO’s hardware products (“Products”) to be free from defects in materials and workmanship when used and stored under normal conditions and in accordance with the instructions for use supplied by RISCO, for a period of (i) 24 months from the date of delivery of the Product (the “Warranty Period”). This Limited Warranty covers the Product only within the country where the Product was originally purchased and only covers Products purchased as new.

Contact with customers only. This Limited Warranty is solely for the benefit of customers who purchased the Products directly from RISCO or from an authorized distributor of RISCO. RISCO does not warrant the Product to consumers and nothing in this Warranty obligates RISCO to accept Product returns directly from end users who purchased the Products for their own use from RISCO’s customer or from any installer of RISCO, or otherwise provide warranty or other services to any such end user directly. RISCO’s authorized distributor or installer shall handle all interactions with its end users in connection with this Limited Warranty. RISCO’s authorized distributor or installer shall make no warranties, representations, guarantees or statements to its end users or other third parties that suggest that RISCO has any warranty or service obligation to, or any contractual privity with, any recipient of a Product.

Remedies. In the event that a material defect in a Product is discovered and reported to RISCO during the Warranty Period, RISCO shall accept return of the defective Product in accordance with the below RMA procedure and, at its option, either (i) repair or have repaired the defective Product, or (ii) provide a replacement product to the customer.

Return Material Authorization. In the event that you need to return your Product for repair or replacement, RISCO will provide you with a Return Merchandise Authorization Number (RMA#) as well as return instructions. Do not return your Product without prior approval from RISCO. Any Product returned without a valid, unique RMA# will be refused and returned to the sender at the sender’s expense. The returned Product must be accompanied with a detailed description of the defect discovered (“Defect Description”) and must otherwise follow RISCO’s then-current RMA procedure published in RISCO’s website at www.riscogroup.com in connection with any such return. If RISCO determines in its reasonable discretion that any Product returned by customer conforms to the applicable warranty (“Non-Defective Product”), RISCO will notify the customer of such determination and will return the applicable Product to customer at customer’s expense. In addition, RISCO may propose and assess customer a charge for testing and examination of Non-Defective Product.

Entire Liability. The repair or replacement of Products in accordance with this Limited Warranty shall be RISCO’s entire liability and customer’s sole and exclusive remedy in case a material defect in a Product is discovered and reported as required herein. RISCO’s obligation and this Limited Warranty are contingent upon the full payment by customer for such Product and upon a proven weekly testing and examination of the Product functionality.

Limitations. This Limited Warranty is the only warranty made by RISCO with respect to the Products. The warranty is not transferable to any third party. To the maximum extent permitted by applicable law, this Limited Warranty shall not apply and will be void if: (i) the conditions set forth above are not met (including, but not limited to, full payment by customer for the Product and a proven weekly testing and examination of the Product functionality); (ii) if the Products or any part or component thereof: (a) have been subjected to improper operation or installation; (b) have been subject to neglect, abuse, willful damage, abnormal working conditions, failure to follow RISCO's instructions (whether oral or in writing); (c) have been misused, altered, modified or repaired without RISCO's written approval or combined with, or installed on products, or equipment of the customer or of any third party; (d) have been damaged by any factor beyond RISCO's reasonable control such as, but not limited to, power failure, electric power surges, or unsuitable third party components and the interaction of software therewith or (e) any failure or delay in the performance of the Product attributable to any means of communication provided by any third party service provider, including, but not limited to, GSM interruptions, lack of or internet outage and/or telephony failure. BATTERIES ARE EXPLICITLY EXCLUDED FROM THE WARRANTY AND RISCO SHALL NOT BE HELD RESPONSIBLE OR LIABLE IN RELATION THERETO, AND THE ONLY WARRANTY APPLICABLE THERETO, IF ANY, IS THE BATTERY MANUFACTURER'S WARRANTY. RISCO does not install or integrate the Product in the end user's security system and is therefore not responsible for and cannot guarantee the performance of the end user's security system which uses the Product or which the Product is a component of.

This Limited Warranty applies only to Products manufactured by or for RISCO. Further, this Limited Warranty does not apply to any software (including operating system) added to or provided with the Products or any third-party software, even if packaged or sold with the RISCO Product. Manufacturers, suppliers, or third parties other than RISCO may provide their own warranties, but RISCO, to the extent permitted by law and except as otherwise specifically set forth herein, provides its Products "AS IS". Software and applications distributed or made available by RISCO in conjunction with the Product (with or without the RISCO brand), including, but not limited to system software, as well as P2P services or any other service made available by RISCO in relation to the Product, are not covered under this Limited Warranty. Refer to the Terms of Service at: <https://riscocloud.com/ELAS/WebUI/UserLogin/License> for details of your rights and obligations with respect to the use of such applications, software or any service. RISCO does not represent that the Product may not be compromised or circumvented; that the Product will prevent any personal injury or property loss by burglary, robbery, fire or otherwise, or that the Product will in all cases provide adequate warning or protection. A properly installed and maintained alarm may only reduce the risk of a burglary, robbery or fire without warning, but it is not insurance or a guarantee that such will not occur or will not cause or lead to personal injury or property loss. CONSEQUENTLY, RISCO SHALL HAVE NO LIABILITY FOR ANY PERSONAL INJURY, PROPERTY DAMAGE OR OTHER LOSS BASED ON ANY CLAIM AT ALL INCLUDING A CLAIM THAT THE PRODUCT FAILED TO GIVE WARNING.

EXCEPT FOR THE WARRANTIES SET FORTH HEREIN, RISCO AND ITS LICENSORS HEREBY DISCLAIM ALL EXPRESS, IMPLIED OR STATUTORY, REPRESENTATIONS, WARRANTIES, GUARANTEES, AND CONDITIONS WITH REGARD TO THE PRODUCTS, INCLUDING BUT NOT LIMITED TO ANY REPRESENTATIONS, WARRANTIES, GUARANTEES, AND CONDITIONS OF MERCHANTABILITY, FITNESS FOR A PARTICULAR PURPOSE, TITLE AND WARRANTIES AGAINST HIDDEN OR LATENT DEFECTS, TO THE EXTENT PERMITTED BY LAW. WITHOUT LIMITING THE GENERALITY OF THE FOREGOING, RISCO AND ITS LICENSORS DO NOT REPRESENT OR WARRANT THAT: (i) THE OPERATION OR USE OF THE PRODUCT WILL BE TIMELY, SECURE, UNINTERRUPTED OR ERROR-FREE; (ii) THAT ANY FILES, CONTENT OR INFORMATION OF ANY KIND THAT MAY BE ACCESSED THROUGH THE PRODUCT SHALL REMAIN SECURED OR NON DAMAGED. CUSTOMER ACKNOWLEDGES THAT NEITHER RISCO NOR ITS LICENSORS CONTROL THE TRANSFER OF DATA OVER COMMUNICATIONS FACILITIES, INCLUDING THE INTERNET, GSM OR OTHER MEANS OF COMMUNICATIONS AND THAT RISCO'S PRODUCTS, MAY BE SUBJECT TO LIMITATIONS, DELAYS, AND OTHER PROBLEMS INHERENT IN THE USE OF SUCH MEANS OF COMMUNICATIONS. RISCO IS NOT RESPONSIBLE FOR ANY DELAYS, DELIVERY FAILURES, OR OTHER DAMAGE RESULTING FROM SUCH PROBLEMS. RISCO WARRANTS THAT ITS PRODUCTS DO NOT, TO THE BEST OF ITS KNOWLEDGE, INFRINGE UPON ANY PATENT, COPYRIGHT, TRADEMARK, TRADE SECRET OR OTHER INTELLECTUAL PROPERTY RIGHT IN ANY EVENT RISCO SHALL NOT BE LIABLE FOR ANY AMOUNTS REPRESENTING LOST REVENUES OR PROFITS, PUNITIVE DAMAGES, OR FOR ANY OTHER INDIRECT, SPECIAL, INCIDENTAL, OR CONSEQUENTIAL DAMAGES, EVEN IF THEY WERE FORESEEABLE OR RISCO HAS BEEN INFORMED OF THEIR POTENTIAL.

Contacting RISCO Group

RISCO Group is committed to customer service and product support. You can contact us through our website (www.riscogroup.com) or at the following telephone and fax numbers:

United Kingdom

Tel: +44-(0)-161-655-5500
support-uk@riscogroup.com

Italy

Tel: +39-02-66590054
support-it@riscogroup.com

Spain

Tel: +34-91-490-2133
support-es@riscogroup.com

France

Tel: +33-164-73-28-50
support-fr@riscogroup.com

Belgium (Benelux)

Tel: +32-2522-7622
support-be@riscogroup.com

USA

Tel: +1-631-719-4400
support-usa@riscogroup.com

China (Shanghai)

Tel: +86-21-52-39-0066
support-cn@riscogroup.com

Israel

Tel: +972-3-963-7777
support@riscogroup.com

