

## Unpacking

Before you begin using the device, please check the version you obtained and ensure that the following items are included in the shipped box:

### Universal Accessories:

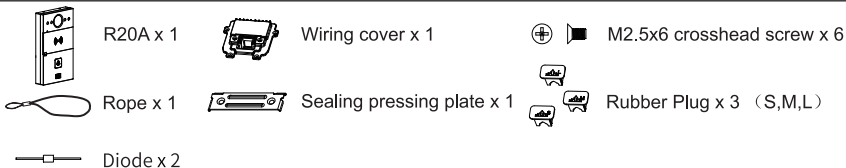

### Wall-mounting Accessories :

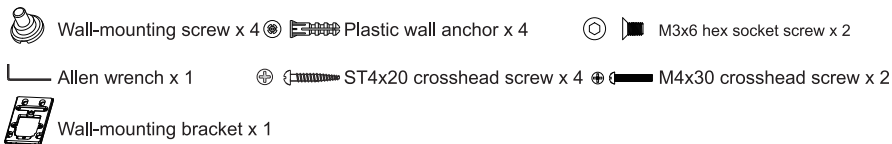

## Product Overview

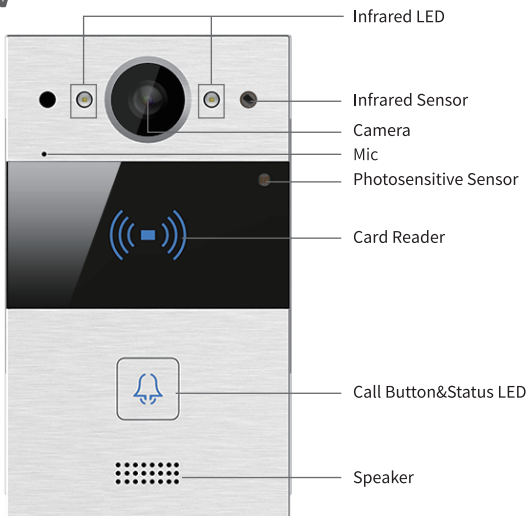

R20A

## Installation Environment

Please do not place device under direct sunlight.

If installing the device indoors, please keep device at least 2 meters away from light, and at least 3 meters away from window and door .

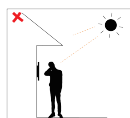

Backlight

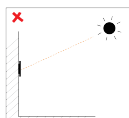

Direct sunlight

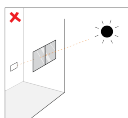

Direct sun through window



Indirect sunlight through window

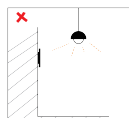

Close to light

## Installation

### Step 1: Wall-mounting bracket Installation

1. With embedded one-gang junction box (86x86 mm or 2x3 inches in size) in the wall.

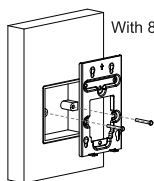

With 86x86 mm junction box.

Fix the wall-mounting bracket on embedded box with two M4x30 crosshead screw.

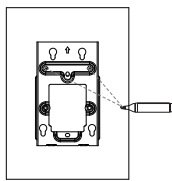

Mark the two holes of the wall-mounting bracket on the wall.

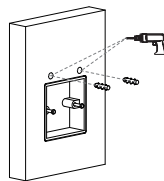

Take down two M4x30 crosshead screws and remove the wall-mounting bracket. Use a hand drill with 6mm diameter bit to make two 25mm depth holes in the marked positions.

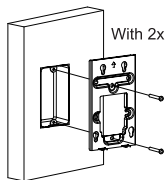

With 2x3 inches junction box.

Fix the wall-mounting bracket on the 2x3 inches junction box with two M4x30 crosshead screw.

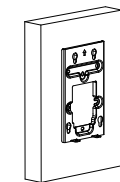

Finish the wall-mounting bracket installation.

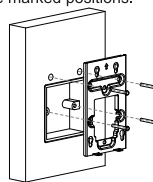

Tighten the wall-mounting bracket on the wall and junction box using two ST4x20 crosshead screw and two M4x30 crosshead screw.

### 2. Without embedded one-gang junction box(86x86 mm or 2x3 inches in size) in the wall.

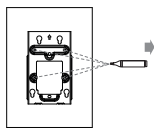

Mark the four holes of the wall-mounting bracket on the wall for the screws.

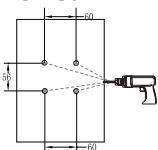

Use a hand drill with 6mm diameter bit to make four 25mm depth holes in the marked positions.

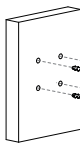

Insert four plastic wall anchors into the holes.

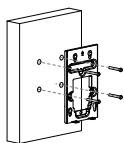

Fix the wall-mounting bracket with four ST4x20 crosshead screw.

### Step 2: Wiring cover Installation

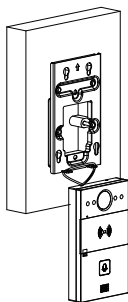

For convenient wiring, hang R20A on the wall-mounting bracket with rope.

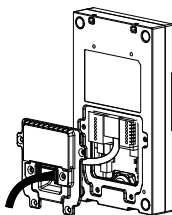

Make cables go through the Wiring cover, connecting to the corresponding interfaces of the main board.

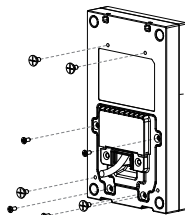

Fasten the Wiring cover with four M2.5x6 crosshead screw, then fix four wall-mounting screws on the back of R20A.

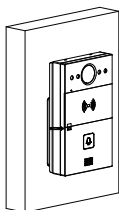

After successful installation, check the stability of device. And remove the protective film.

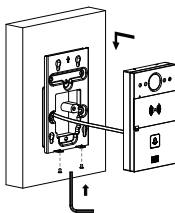

Insert the four wall-mounting screws on the device into the corresponding holes on the wall-mounting bracket, and then press down to slide the wall-mounting screws into the groove. Then use the Allen Wrench to tighten the device with two M3x6 hex socket screws.

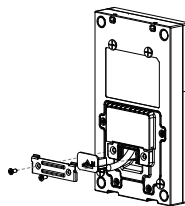

Select a suitable size rubber plug to push all the cables into the wiring cover. Fix sealing pressing plate to the wiring cover with two M2.5x6 crosshead screws.

## Device Wiring

### ⚠ Warning

When you connect a device containing a coil, such as a relay or an electromagnetic lock, it is necessary to protect the intercom against voltage peak while switching off the induction load. For this way of protection we recommend a diode 1 A / 200 V (included in the accessories) connected antiparallel to the device.

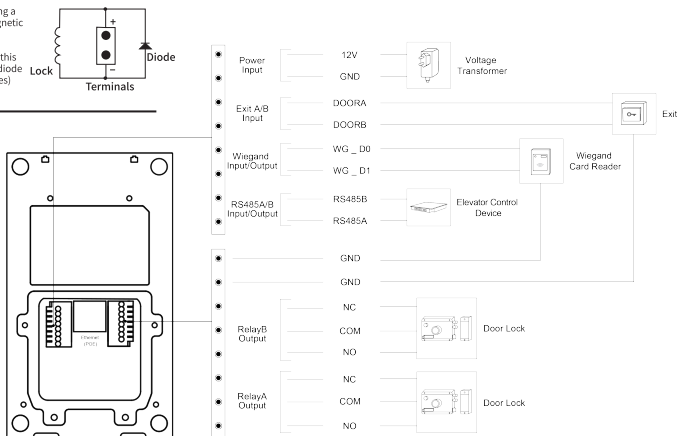
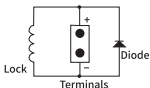

## Application Network Topology

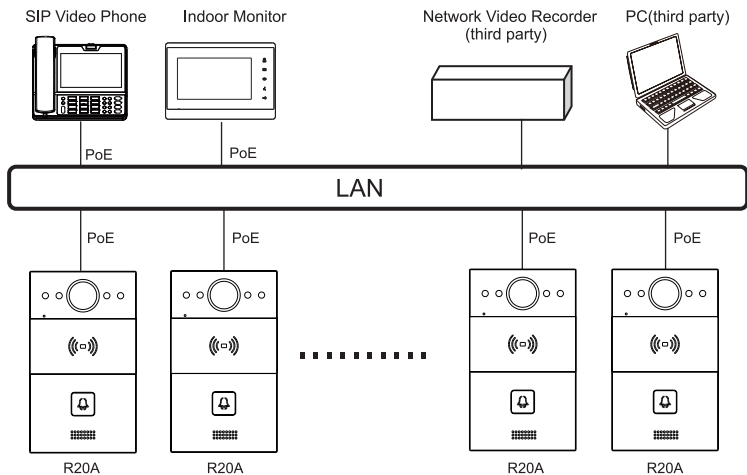

## IP Announcement

1. While R20A starts up normally, hold the **Call button** for several seconds after the Status LED turns blue, voice system will enter IP announcement mode.
2. In announcement mode, the IP address will be announced periodically.
3. Press **Call button** again to quit the announcement mode.
4. In announcement mode, phone announces "IP 0.0.0.0" if no IP address is gained.

## Configuration

1. Access the Web UI: Input the IP address into web browser to configure the phone.
2. Account Registration: On web UI, go to the path: **Account > Basic** page to register account and fill in the account information. (*Please refer to admin guide for more information*)
3. Configure the Push Button: On web UI, go to the path: **Intercom > Basic > Push Button** to configure the call number.
4. Configure the code to open the relay: On web UI, go to the path: **Intercom > Relay** -> **Relay ID/DTMF** and choose the DTMF code number in corresponding area.

## Operation

### Make a call:

Press the **Call button** to call indoor SIP Phone.



### Unlock:













During the talk, called party can press pre-configured Unlock key to unlock the door.

### Receive a call:

R20A supports Auto Answer by default. Incoming call will be answered automatically.

## Indicators

 Light ON  Light OFF

Name	Status	Description
Status indicator	Blue	 Normal status
		 0.25sec →  0.25sec Calling
	Red	 0.05sec →  0.05sec Restarting
		 0.25sec →  0.25sec Network is unavailable
	Green	 Initializing/Talking on a call
		 0.25sec →  0.25sec Receiving a call
	Red/Blue	 0.05sec →  0.05sec Firmware upgrading

**Note:** For more LED settings, please refer to R20 webUI: Intercom -> LED Setting.

### Notice Information

Akuvox R20A firmware contains third-party open source software under the terms of the GNU General Public License (GPL). Akuvox is committed to meeting the requirements of the GNU General Public License (GPL) and will make all required source code available.

The source code of software under the terms of GNU GPL can be downloaded online: <http://www.akuvox.com/gpl>.

Information contained in this document is believed to be accurate and reliable at the time of printing. This document is subject to change without notice, any update to this document can be viewed on Akuvox's website: <http://www.akuvox.com> © Copyright 2022 Akuvox Ltd. All rights reserved.



**AKUVOX (XIAMEN) NETWORKS CO., LTD.**

ADD: 10/F, NO.56 GUANRI ROAD, SOFTWARE PARK II, XIAMEN 361009, CHINA  
[www.akuvox.com](http://www.akuvox.com)

